

GeOpus LT “universal coding protocol”

This file explains how GeOpus LT coding is used to create field-to-finished drawings.

TXT file data format

The GeOpus LT “universal coding protocol” uses text files (ASCII files) containing coordinate data representing 5 columns, delimited using a comma, semicolon or tab character (this delimiter is set in the TXT import function dialog).

Example text file:

```
5263,168499.724,215836.003,12.350,-dl2b
5264,168499.732,215836.562,11.462,-zo2
5265,168499.630,215837.257,11.561,zo2pp
5266,168499.591,215837.805,12.327,bm
5267,168499.552,215838.293,12.976,-ha2
5268,168499.788,215838.026,12.319,-ad2
5269,168501.283,215831.453,12.574,ad2s
5270,168501.025,215832.870,12.570,-wa2
5271,168501.446,215830.483,12.579,-as1
....
```

The columns represent point name or number, X-coordinate, Y- coordinate, Z-coordinate and coding. The coordinate grid system (XY or YX) can also be set in the TXT import function dialog.

The GeOpus code field length is not limited, however usually this is limited by the software used on your fieldbook, total-station or GPS system.

Verify your documentation or contact your for supplier for more information regarding your code field length.

The coding examples in this document will be represented in color, each color representing an element of the field codes:

FEATURECODE
LINNUMBER
CONSTRUCTIONCODE

Next chapters will explain the GeOpus LT “universal coding protocol” in detail.

Coding points.

To create a solitary point object the surveyor enters 1 or more letters representing the feature code.

Examples:

TR
MANHOLE
F
POLE

GeOpus LT will translate these codes into a solitary point and will insert a symbol (assuming the symbol is defined in the current drawing).

The name of the symbol needs to equal the code entered at the point. Thus GeOpus LT places a block named "MANHOLE" whenever you measure and code a point using feature code "MANHOLE"

If the symbol is not defined in the current drawing, GeOpus LT will not insert a block but will prompt the user in the drawing report that there is no block defined for the specific feature code. The drawing report is opened whenever the file import is completed.

Coding linework.

To create a line the surveyor enters a feature code containing 1 or more letters followed by 1 or more numbers representing the line number.

Examples:

F1
WALL1
CEN55
BUILD2
B5

At import GeOpus LT will connect every point that has the same code combination (feature code + line number) using a (poly)line.

This enables the surveyor to use an unlimited number of lines.

However it is also possible to reuse line numbers. Whenever you enter a "-" or minus sign before the feature code a new line is started and this will close the previous line (for that code combination)

Example (coding sequence):

FENCE1 start line FENCE1
FENCE 2 start line FENCE2
FENCE 1 continue line FENCE2
WALL1 start line WALL1
- FENCE 1 start a new line FENCE1 (previous FENCE1 is finished)
...

In the above example the surveyor starts a new line using code combination -FENCE1 (last line in the example), the previous line FENCE1 will be created in the drawing and is considered finished.

This way the surveyor does not need to increment line numbers for every newly created line on the field.

The surveyor can also code **multiple** lines at the **same** point, just separate the different code combinations using 1 or more spaces. This for example enables the surveyor to simultaneously continue and start a new line at the same point.

Example (coding sequence):

-KERB1 start a line KERB1
KERB1 -V1 continue line KERB1 and simultaneously start line V1
KERB1 continue line KERB1
V1 continue line V1

...

The surveyor is of course free to choose which line he continues first after the multiple codes. The sequence for adding multiple codes at a point is free also.

IMPORTANT NOTICE:

Line number 0 (zero) is not allowed when coding lines. Line number (zero) however is used when the surveyor wants to add construction code T (text) to solitary points. This way GeOpus LT can distinguish the feature code from the code T and the entered text. Without the 0 (zero) the entered complete string would be interpreted a feature code.

You can find more information regarding construction code T further in this document.

Using construction codes.

Beside 'common' codes the surveyor can add optional construction codes. This enables the surveyor to create special line segments, constructed lines and/or (aligned) texts. GeOpus LT construction codes enables the surveyor to create complete field-to-finish drawings within BricsCAD.

Construction codes are always entered following the line number.

IMPORTANT NOTICE FOR ADDING DISTANCES USING CONSTRUCTION CODES

Several construction codes make use of variables like for example distances. The surveyor can enter these distances in millimeter or meter. Important to know is that how GeOpus LT interprets these entered distances. When a distance is added with a decimal point (,) the distance is considered to be entered in meters, if the entered distance doesn't contain a decimal point (,) the distance is considered entered in millimeters (mm).

Examples:

.1	10 centimeter
100	100 millimeter
1.	1 meter
1000	1000 millimeter or 1 meter
0.50	50 centimeter
0.2	20 centimeter
2.5	2,5 meter
10	10 millimeter

NOTICE REGARDING MEASURED AND CONSTRUCTED POINTS:

Whenever the surveyor adds construction codes, GeOpus LT in most cases will create computed points. These computed points will also receive an elevation value. In most cases this will be the elevation value from the measured point it is constructed from.

The GeOpus LT software will always internally distinguishes measured points from constructed points.

GeOpus LT will also split both measured and constructed points into different layers.

Construction code tutorial.

Code C: curved segment to the next point

Whenever the surveyor enters the construction code C a curved segment is created to the next measured point. At least 2 times code C has to be entered to create a curve. If no code C is entered the following line segment will be straight again.

There is no limit for the number of points to measure a curve. GeOpus LT will always create curves using 3 following points. However a polyline will be created with bulged segments from measured point to measured point. If the number of points is even, the last curved segment will be computed based on the 3 last points.

This code can also be entered at the start of a line.

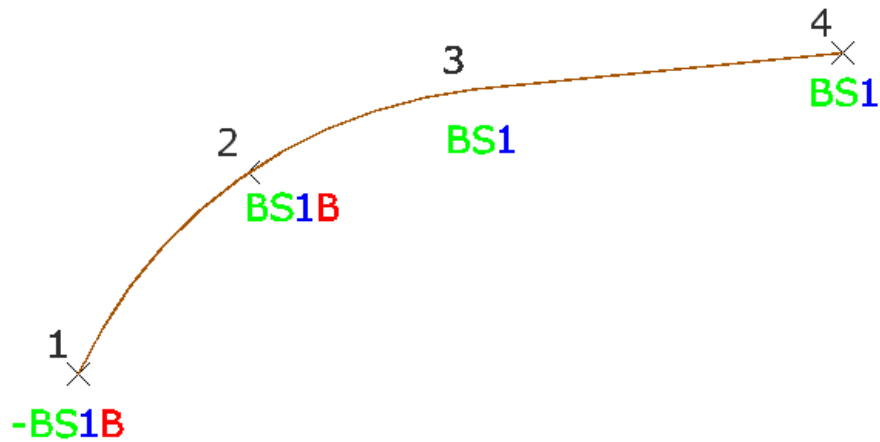

Code CC: break point curve

The surveyor can use code CB to simultaneously end and start a curve at the same point. This code is typically used when the curve direction or radius changes or refracts in a point.

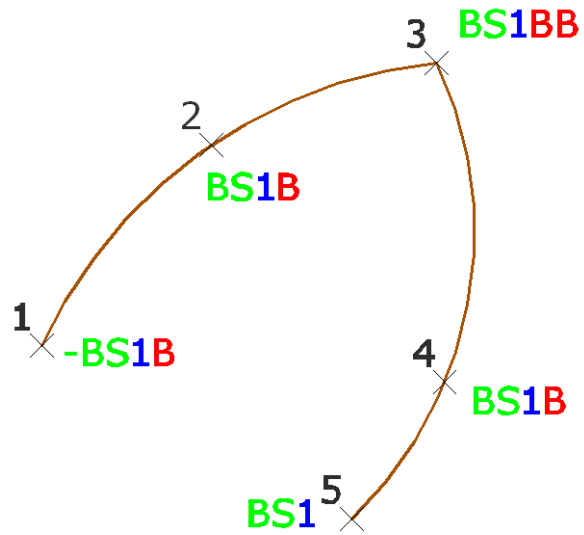

Code PP: parallel line through measured point

Whenever a line is started (point 1 in the example below) the surveyor can create one or more parallel line(s) along the measured line (BS1 in the example below).

The surveyor needs to measure the offset through points using the same feature code and line number combination as the line is started with (BS1), added with code PP.

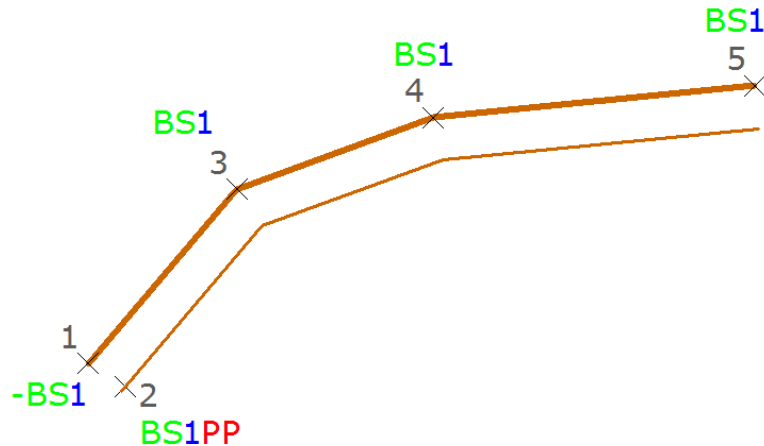

REMARK: GeOpus LT will compute the elevation difference between start point of the line and the measured offset through point and will add this difference for all constructed points on the parallel line.

OPTIONAL parameter: "feature code": by default the parallel line will be created in the same layer as the measured line. If the surveyor adds an optional feature code following code PP the constructed parallel line will be created in a different layer.

Example:

BS1PPGP (GP represents the feature code for the parallel line).

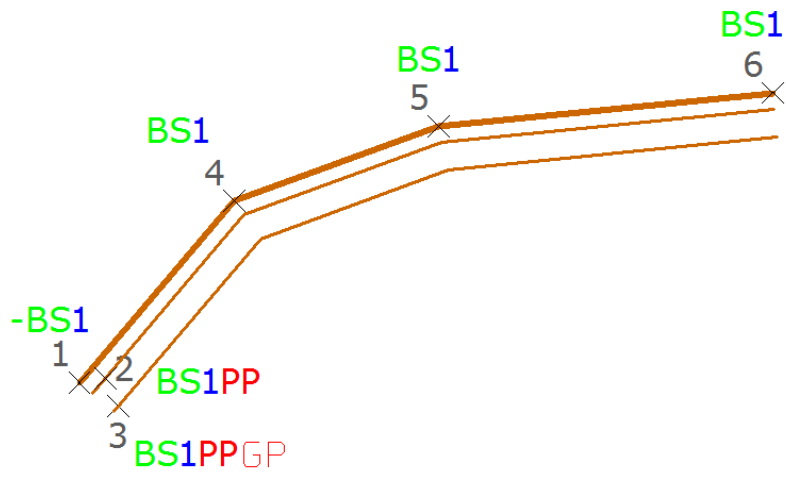

Code PL and PR: parallel line using side and distance

At the start point of a line the (point number 1 in the example) the surveyor can create a parallel line along the measure line (BS1 in the example) using side and distance.

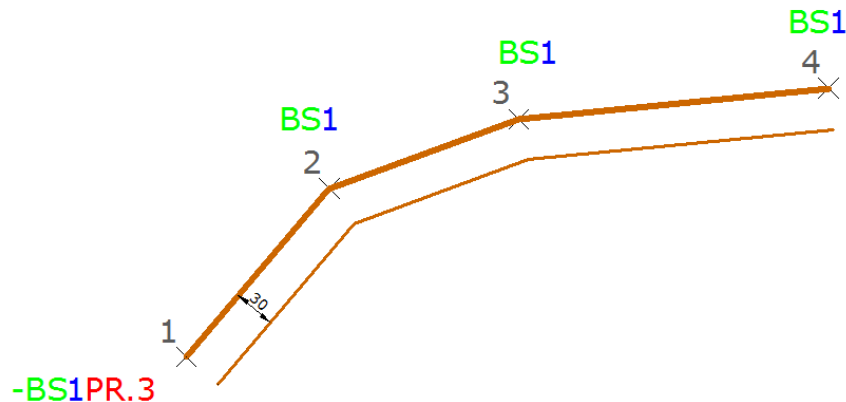

Add PR for a parallel line at the right side along the measured line.
Add PL for a parallel line at the left side along the measured line.

Next the distance is entered. Distances without a decimal point (.) are considered entered in millimeter, distances entered with a decimal point (.) are considered entered in meters.

OPTIONAL parameter: "elevation difference":

The surveyor can add an optional elevation difference parameter following the offset distance using a positive or negative value.

OPTIONAL parameter: "feature code":

The surveyor can add an optional feature code for the parallel line, this can be done following the offset distance or elevation difference.

Examples:

-BS1PR300-.1 (-.1 representing a negative elevation difference of 10cm)

-BS1PL300HG (HG represents the feature code for parallel line)

-BS1PL300+150HG (+150 represents a positive elevation difference of 15cm and HG represents the feature code for parallel line)

Code DL and DR: perpendicular line

The surveyor can create a perpendicular line at a point on a measured line.

When no distance is added following the code PR or PL, the default set length is used.

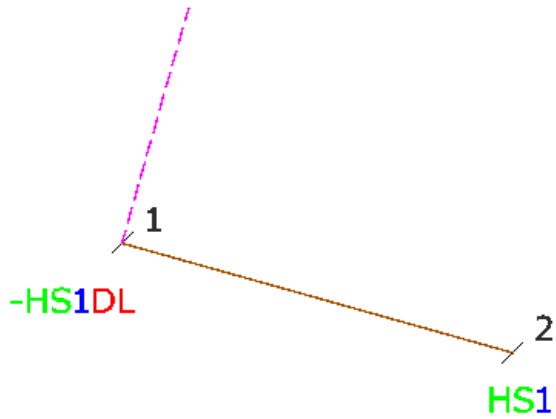

OPTIONAL parameter: "distance":

If a distance is entered the default set distance is overruled.

Examples:

HS1DL300 (300 represents a distance of 300mm)

HS1DL2.3 (2.3 represents a length of 2,30m or 230cm)

Code DDL and DDR: perpendicular line at start and end point of a line

These codes enables the surveyor to create a perpendicular line at the start and end point of a (poly)line. This code can be entered at any point of the measured line but will always result in a perpendicular line at the start and end point.

When no distance is added following the code, the default set length is used.

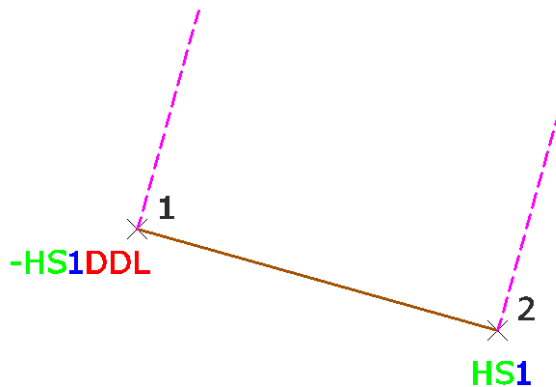

OPTIONAL parameter: "distance":

If a distance is entered following the code the default distance is overruled.

Voorbeeld:

HS1DDL500 (500 represents a length of 500mm or 50cm)

HS1DDL8.3 (8.3 represents a length of 8,30m)

Code DNL and DNR : perpendicular line + aligned text

These codes enables the surveyor to simultaneously create a perpendicular line at a point on a measured line and a aligned text. The perpendicular line is created at the point the code is entered. The text is aligned along the midpoint of the segment that will be created between the point the code is entered and the following measured point.

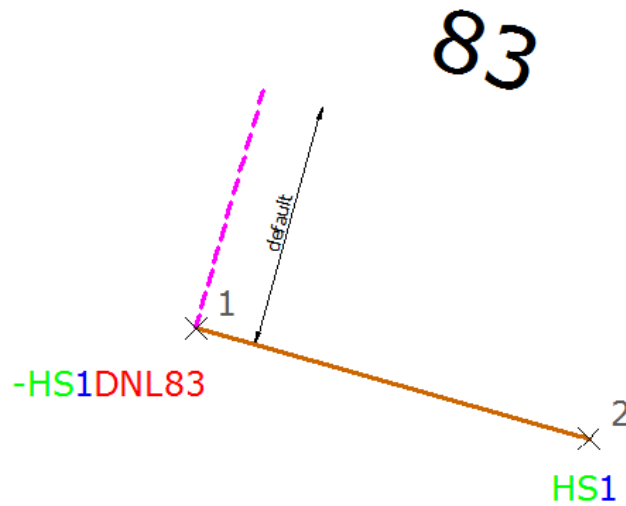

The default set length is always used.

Any string entered following code DNL or DNR is interpreted as aligned text.

The default offset distance is always used for aligned text N.

Code DDNL and DDNR : perpendicular line at the start and endpoint + aligned text

These codes enable the surveyor to simultaneously create a perpendicular line at the start and endpoint of a measured line and an aligned text. The perpendicular lines are always created at the start and end point of the measured (poly)line. The text is aligned along the midpoint of the segment that will be created between the point the code is entered and the following measured point.

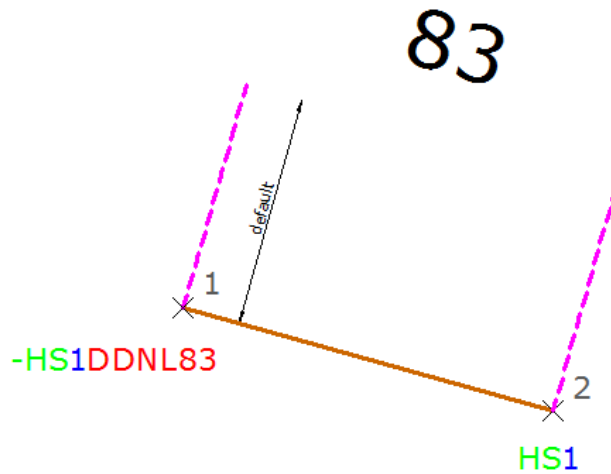

The default set length is always used.

Any string entered following code DNL or DNR is interpreted as aligned text.

The default set offset distance is always used for aligned text N.

Code OL and OR: construct an offset on a baseline

These codes enable the surveyor to construct an offset at any point (start point included) of a measured line.

The base is always the last measured point and the following point measured.

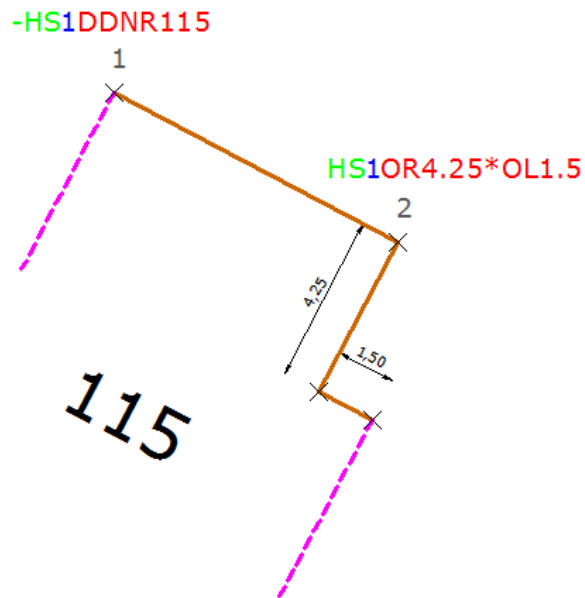

In this example above the code is entered twice at the same point.

More information on adding multiple construction codes can be found in the "Adding multiple construction codes" chapter.

Code LV and LA: lengthen or shorten a line

These codes enable the surveyor to lengthen or shorten a measured line segment.

The base is always the previous line segment. This code can be used at any point of a line (start point included).

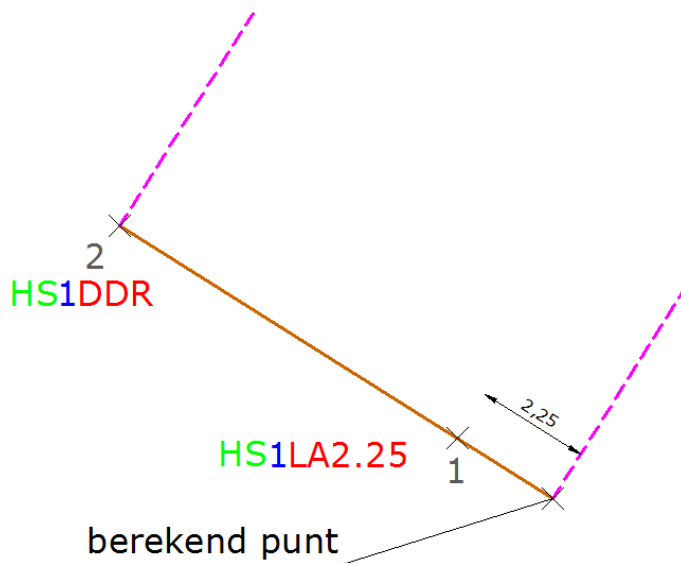
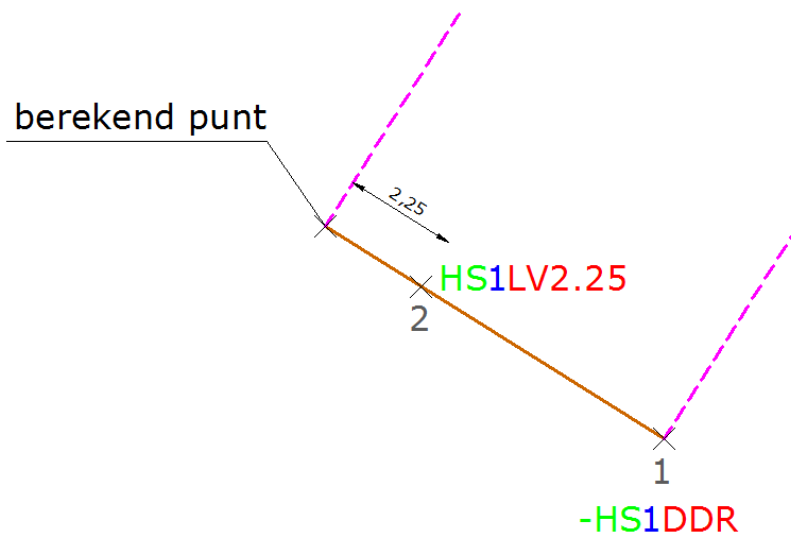

Code S : mirror a line

This enables the surveyor to create a mirrored line. A direction is measured and the line is mirrored from the previous point.

The line length is computed between the base point (2) and mirror point (3).

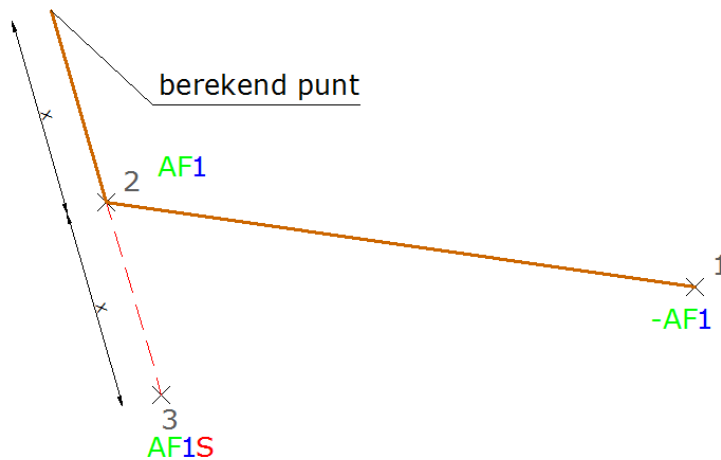

OPTIONAL parameter: "distance"

The surveyor can enter a line length distance following code S.

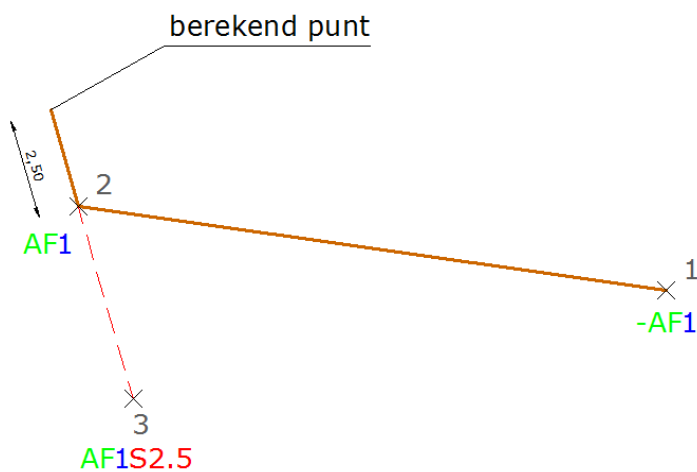

This codes can be entered at any point of a line (start point included) or even when measuring lines containing only 2 measured points (example below).

berekend punt

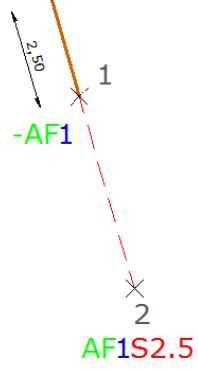

Code PB : project on baseline

This code enables the surveyor to insert a new projected point into a measured line. The point is projected on the previous measured line segment (point 1 and 2 in the example below).

This code can only be used after 2 points have been measured for the specific line.

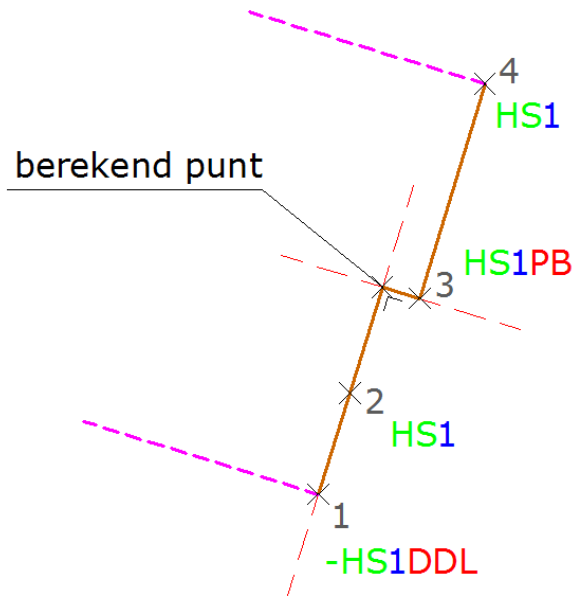

In this example above a point is constructed projecting point 3 (with code PB entered) on the extended base between measured point 1 and point 2.

Code I : compute intersection of 2 lines using 4 points

This enables the surveyor to compute an intersection point (using 4 points) and insert this point into the measured line.

Code I is entered at the second point of the 4 point sequence.

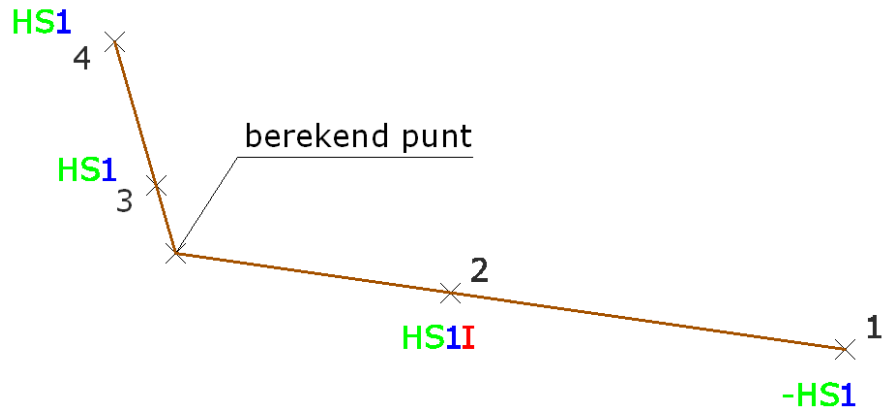

Code H: perpendicular corner to the next point

This enables the surveyor to compute and insert a perpendicular corner point to the next measured point.

This code can be used at any point of a measured line. When using this code at the start point of a line (1) the base is formed using the 2 next following points (2-3). In the other case the current point and previous point is used to create the base (4-3).

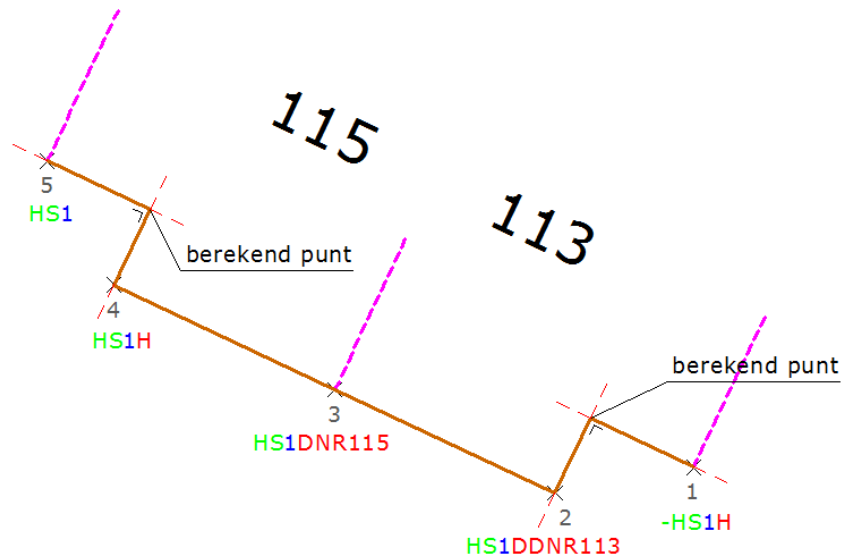

Code SR: close using a straight segment

This code enables the surveyor to close a polyline using a straight segment.

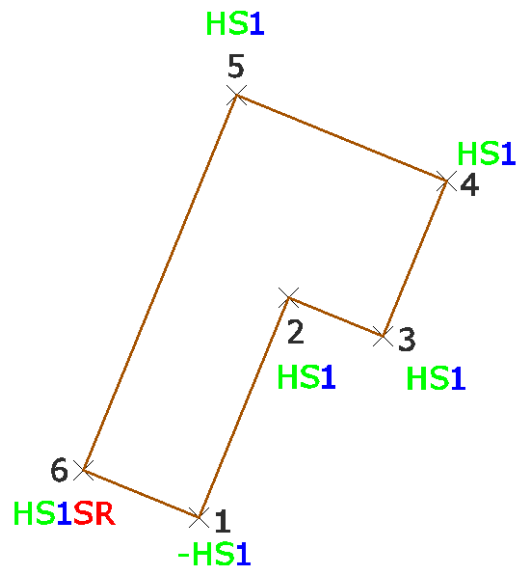

Code SB: close using a curved segment

This code enables the surveyor to close a polyline using a curved segment.

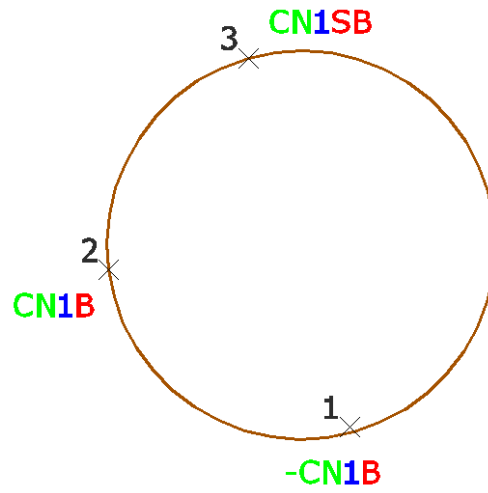

In this example after entering 2 times code C (point 1 and 2) code CC is entered at the last point of a line (point 3) thus creating a circle.

REMARK: GeOpus LT doesn't create circles but always uses curved polyline segments from point to point using the different point elevations.

Code VH: square or rectangle

This code enables the surveyor to create a square or rectangle measuring 2 points.

If no distance is added a square is created.

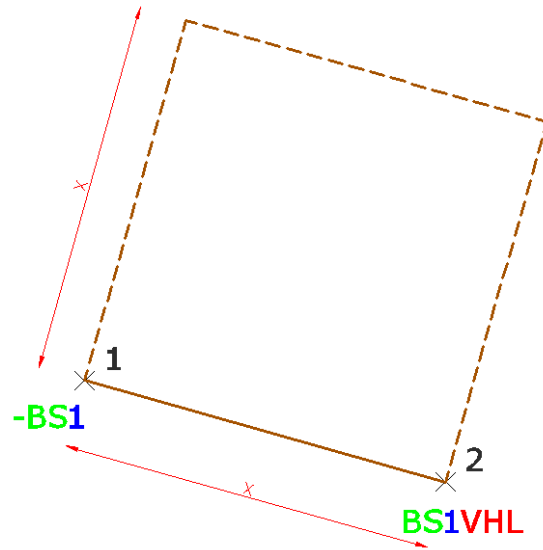

OPTIONAL parameter: "distance"

The surveyor can enter a distance resulting in a rectangle.

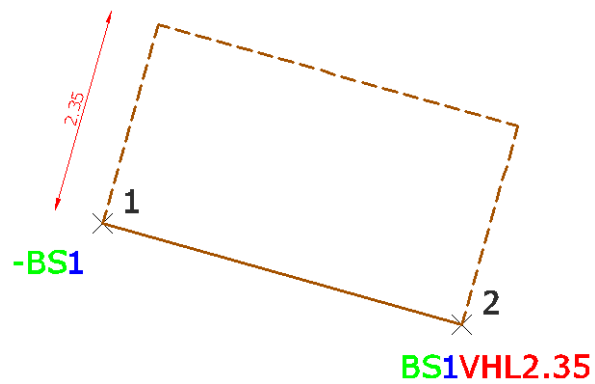

Code RH: rectangle using 3 points

This code enables the surveyor to create a rectangle measuring 3 points.

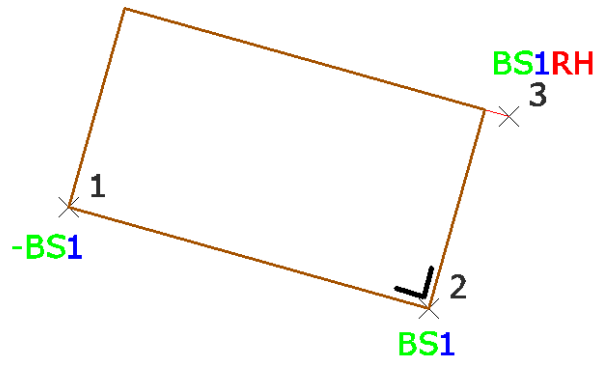

Code PG: parallelogram using 3 points

This code enables the surveyor to create a parallelogram measuring 3 points.

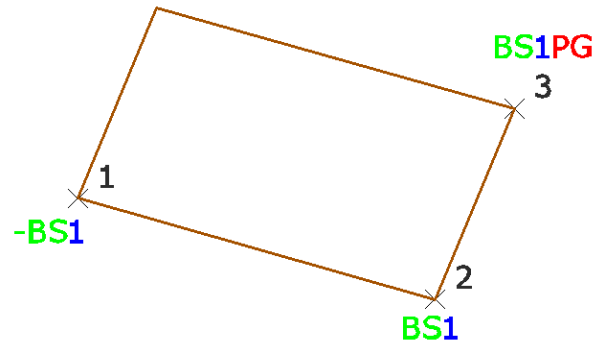

Code C: circle using 3 points

This code enables the surveyor to create a circle measuring 3 points.

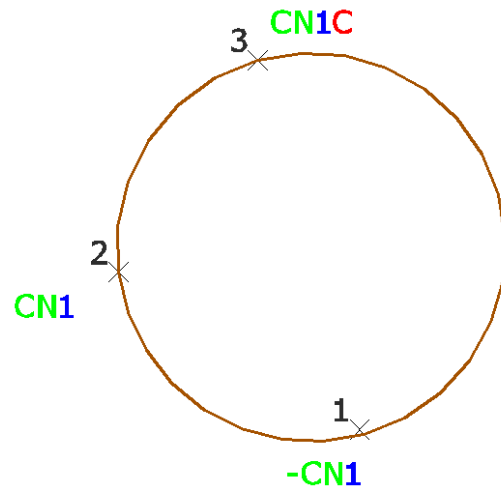

REMARK: GeOpus LT doesn't create circles but always uses curved polyline segments from point to point using the different point elevations.

Code CD: circle using 2 points (diameter)

This code enables the surveyor to create a circle measuring 2 points representing the diameter of the circle.

This code can be entered at the first or second (and last) point of the line.

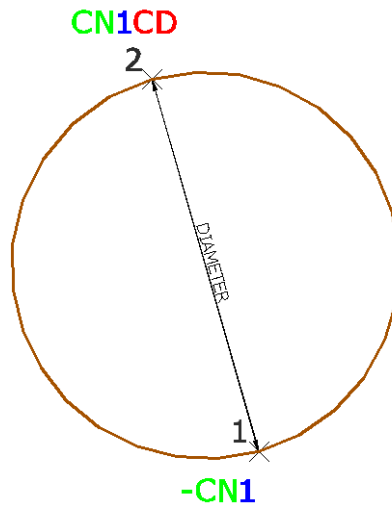

REMARK: GeOpus LT doesn't create circles but always uses curved polyline segments from point to point using the different point elevations.

Code CR: circle using 2 points (radius)

This code enables the surveyor to create a circle measuring 2 points representing the radius of the circle.

This code can be entered at the first or second (and last) point of the line.

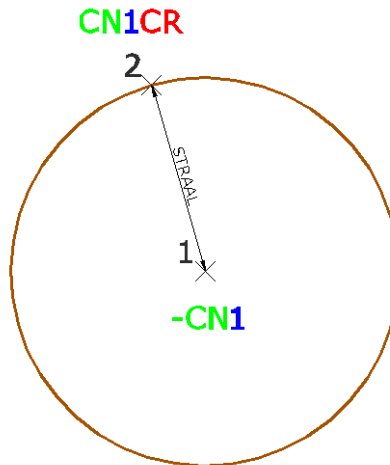

REMARK: GeOpus LT doesn't create circles but always uses curved polyline segments from point to point using the different point elevations.

Code T: text

If the surveyor wants to add text to the drawing code T is used.

This code can be used at solitary points or points measured for linework.

For lines the text can be aligned along a measured line if code L or R is added (left or right).

IMPORTANT NOTICE:

Line number 0 (zero) is not allowed when coding lines. Line number (zero) however is used when the surveyor wants to add construction code T (text) to solitary points. This way GeOpus LT can distinguish the feature code from the code T and the entered text. Without the 0 (zero) the entered complete string would be interpreted a feature code.

Examples:

S5TSEWER : resulting in a text "SEWER" at the point of line S5

CEN1TRSTREETNAME : resulting in an aligned text "STREETNAME" along the next line segment of CEN1

>TROAK : resulting in a text "OAK" at solitary point measured with feature code TR

Code N: text

These texts are automatically created whenever the surveyor uses codes **DN** or **DDN**.

These texts are always aligned along the measure line segments.

Adding multiple construction codes.

Adding multiple construction codes to a single point is possible. This can be useful when the surveyor wants to add for example a parallel line at the start of a point and start the line with a curve. Multiple construction codes have to be separated using a special * # or / (asterisk, hashtag or slash).

Ignore measured elevations.

If in some cases the surveyor wants to ignore the measured elevation of a point this can be done using negative point names or numbers. Whenever the surveyor uses a negative point name or number GeOpus LT will not store the point elevation in the drawing. Thus the elevation of the point will be a null string.

These points will not display an elevation when using the GeOpus Tooltip to view point properties. When converting objects from 2D into 3D later in the drawing, the surveyor can add a new absolute elevation value for these points (f.e. -999m).