

ELECTRONIC TOTAL STATION

GTS-300 **SERIES**
GTS-301D
GTS-302D
GTS-303D
GTS-303

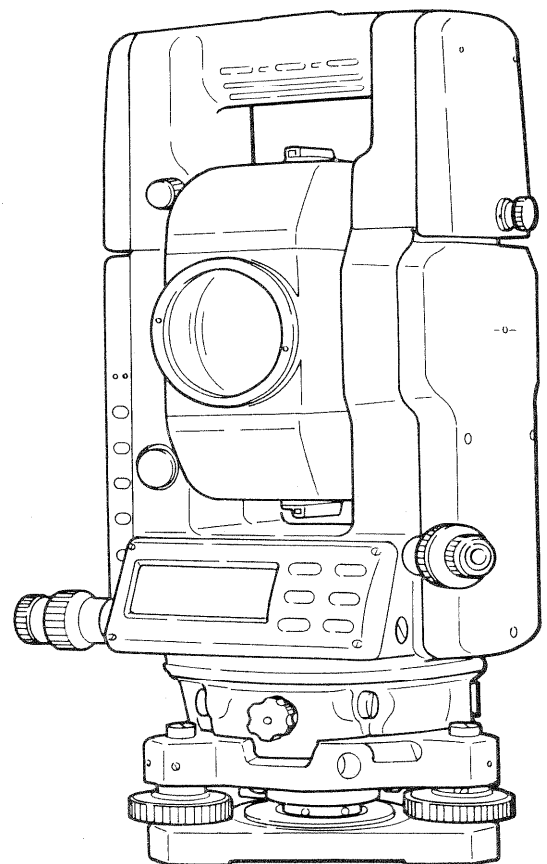
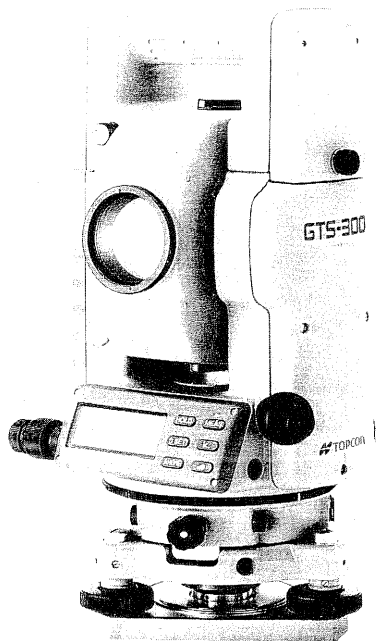

FOREWORD

Thank you for purchasing the TOPCON Electronic Total Station GTS-300 series. To get the best use from the instrument, please carefully read these instructions and place this manual in a convenient location for future reference.



GENERAL HANDLING PRECAUTIONS

1. Care should be taken to avoid shock to the instrument.
Always provide some cushioning material to minimize risk of shock during transportation. If exposed to heavy shock, the instrument cannot be expected to function properly when measuring.
2. When carrying the instrument.
Always remove the instrument from its tripod when carrying at the site. Hold the instrument bottom and support in your hands. If it must be carried with the tripod attached, never carry the instrument horizontally over the shoulder. Always keep the instrument in a vertical position when carrying.
3. Do not expose the instrument to direct sunlight for a long time.
Never leave the instrument in extreme heat longer than necessary. It could adversely affect its performance. Never expose the instrument without a filter to direct sunlight. It may damage the components inside the instrument.
4. Any sudden change of temperature to the instrument or prism may result in a reduction of measuring distance range, i.e when taking the instrument out from a heated vehicle.
5. Check the battery indicator.
Be sure to check the battery for voltage level before using the instrument.

CONTENTS

●	STANDARD SET COMPOSITION	1
1.	NOMENCLATURE AND FUNCTIONS	2
1.1	Nomenclature.....	2
1.2	Display Marks.....	6
1.3	Operating Keys.....	7
1.4	Data Output [REC].....	9
2.	PREPARATIONS FOR MEASUREMENT	10
2.1	Power Connection.....	10
2.2	Leveling the Instrument.....	10
2.3	Power Switch ON.....	12
2.4	Remaining Battery Capacity.....	13
2.5	Vertical Angle Tilt Correction.....	14
3.	ANGLE MEASUREMENT	15
3.1	Measuring a Horizontal Angle Right and a Vertical Angle.....	15
3.2	Measuring a Horizontal Angle Left.....	16
3.3	Measuring a Repetition Angle.....	16
3.4	Setting a Required Horizontal Angle.....	18
4.	DISTANCE MEASUREMENT	19
4.1	Setting the Atmospheric Correction Value.....	19
4.2	Setting the Prism Constant.....	19
4.3	Measuring the Distance (Continuous Measurement Mode).....	19
4.4	Measuring the Distance (N-Time Measurement/Single Measurement).....	20
4.5	Stake out (SO).....	21
5.	TRACKING AND COARSE MEASUREMENTS	25
6.	COORDINATES MEASUREMENT	26
6.1	Setting Coordinate Values of Occupied Point (OCC. POINT).....	26
6.2	How to enter the instrument height/prism height.....	28
6.3	3-dimensional coordinate measurement.....	30
7.	SPECIAL MODE	32
7.1	Remote Elevation Measurement (REM).....	32
7.2	Missing Line Measurement (MLM).....	35
7.3	Offset Measurement Mode.....	37
8.	OTHER FUNCTIONS	39
8.1	Set Audio Mode.....	39
8.2	Auto Power Off (APF ON/OFF).....	39
8.3	Lighting for the Reticule and the Indicator.....	39
9.	POWER SOURCE AND CHARGING	40
9.1	Handle Battery (Internal) BT-24Q.....	40
9.2	Charging the External Power Sources BT-3Q and BT-3L.....	41
10.	DETACHABLE TRIBRACH	42
11.	PRECAUTIONS	43
12.	ATMOSPHERIC CORRECTION AND PRISM CONSTANT	44
12.1	Atmospheric Correction.....	44
12.2	Atmospheric Correction Calculation.....	45
12.3	Prism Constant.....	45
12.4	How to Set the Atmospheric Correction (Temperature & Atmospheric Pressure) and Prism Constant.....	46
13.	CORRECTION FOR REFRACTION AND EARTH CURVATURE	48
13.1	Distance Calculation Formula.....	48

14. SELECTING MODE	49
14.1 Items of the Selecting Mode	49
14.2 How to Set the Selecting Mode.....	51
14.2.1 Selecting the setting mode for selecting or N-time distance measurement.....	51
14.2.2 How to set the selecting mode	52
14.2.3 How to set N-time distance measurement.....	53
15. CHECK AND ADJUSTMENT	54
15.1 Checking and Adjusting the Instrument Constant.....	54
15.2 Checking the Optical Axes of EDM and Theodolite	55
15.3 Checking and Adjusting Theodolite Function.....	55
15.3.1 Checking and adjusting the plate level	56
15.3.2 Checking and adjusting the circular level	56
15.3.3 Checking and adjusting the vertical cross-hair line	57
15.3.4 Checking and adjusting the collimation of the instrument.....	57
15.3.5 Checking and adjusting the optical plummet telescope	58
15.4 Adjusting Vertical Angle 0 Datum.....	59
15.5 How to Set the Instrument Constant	60
16. ERROR DISPLAYS	61
17. SPECIAL ACCESSORIES	62
18. BATTERY SYSTEM	66
• In case of Handle Battery BT-24Q.....	66
• In case of External Battery Pack.....	66
• Charging	67
19. PRISM AND REFLECTOR SYSTEM	68
20. SPECIFICATIONS	69

STANDARD SET COMPOSITION

Standard Set

1. GTS-300 series (with lens cap)..... 1 pc.
2. Handle battery BT-24Q..... 1 pc.
3. Battery charger BC-20B or BC-20C..... 1 pc.
4. Tool kit with case [2 rod pins, screwdriver, hexagonal wrench,
cleaning brush, silicon cloth, 2 fuses (4A)]..... 1 set
5. Plastic carrying case..... 1 pc.
6. Sunshade..... 1 pc.
7. Plastic rain cover..... 1 pc.
8. Instruction manual..... 1 vol.
9. Field chart..... 1 sheet

(Make sure that all of the above items are with the instrument when purchased.)

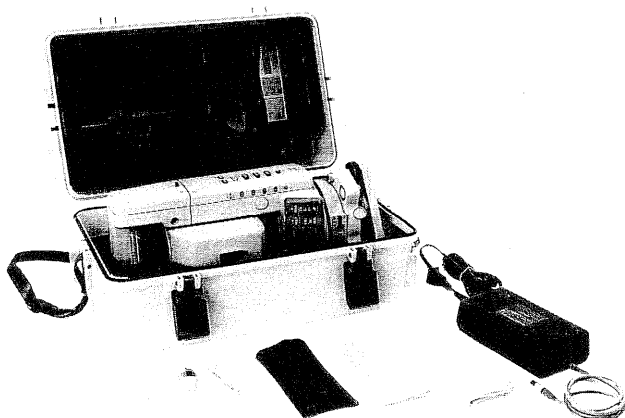

Remarks: 1. Battery charger BC-20C is for AC 230V and BC-20B is for AC 120V.
2. Plumb bob set and plumb bob hook are supplied for certain markets.

1. NOMENCLATURE AND FUNCTIONS

1.1 Nomenclature

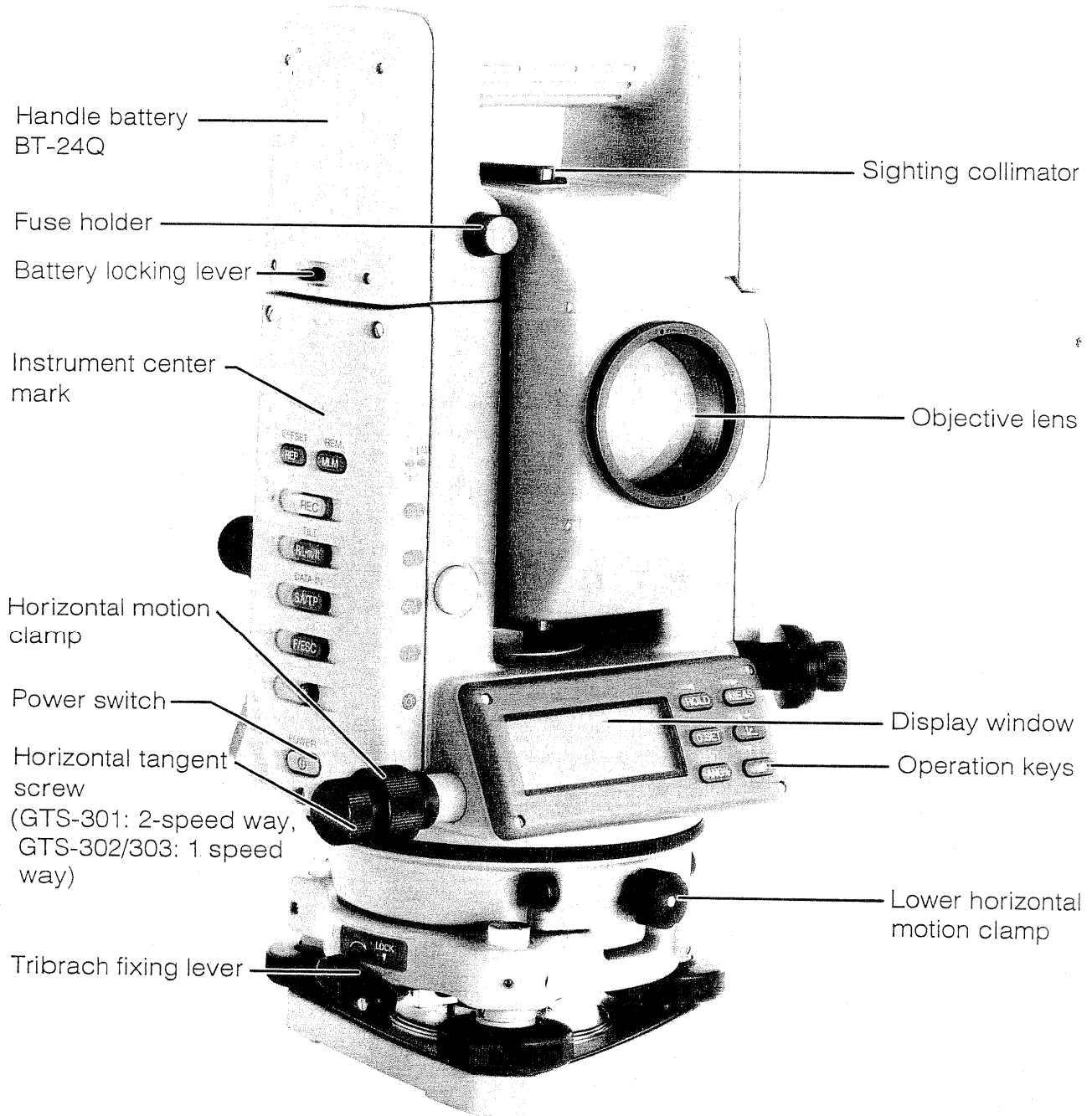

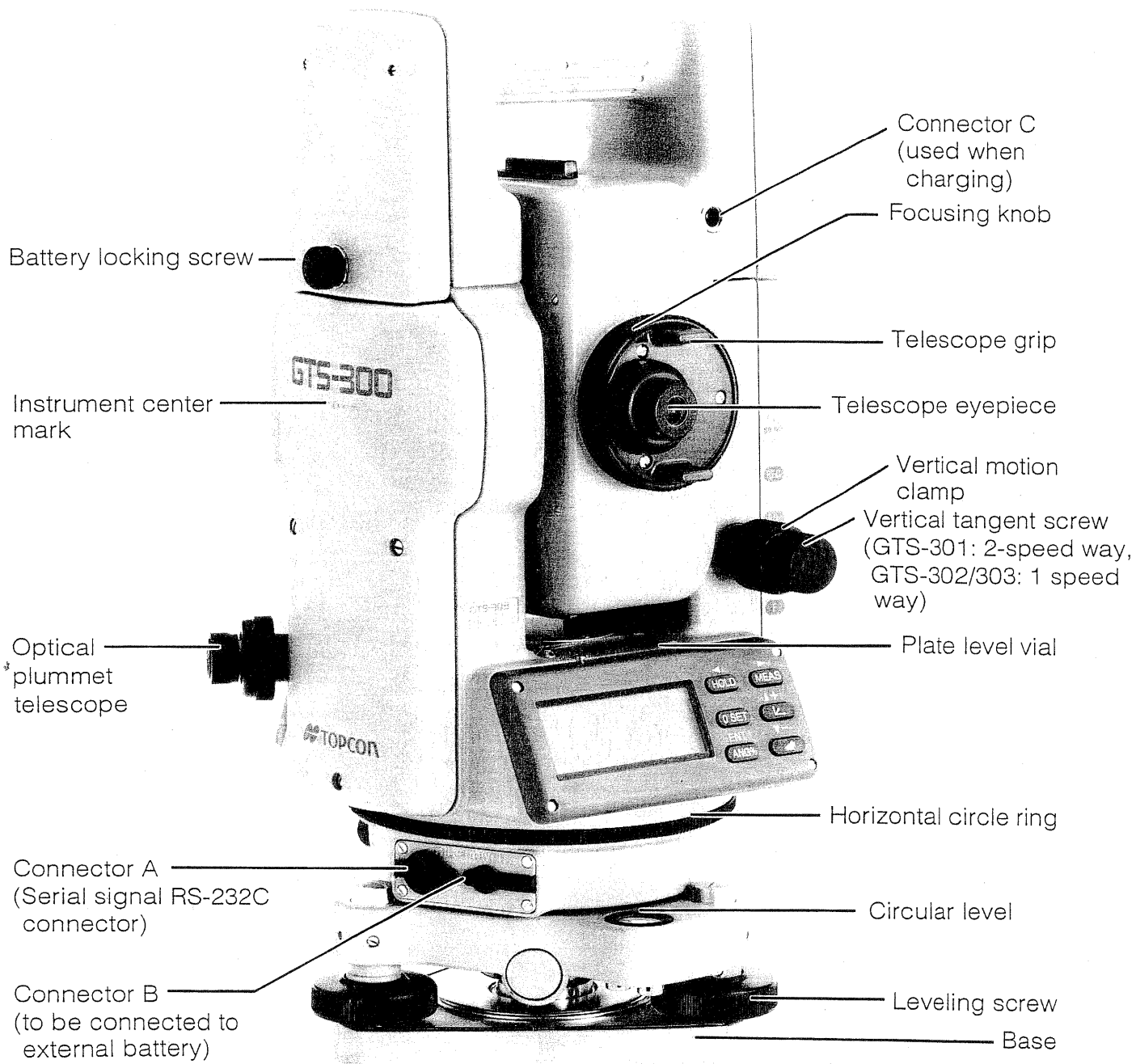

For Certain Markets

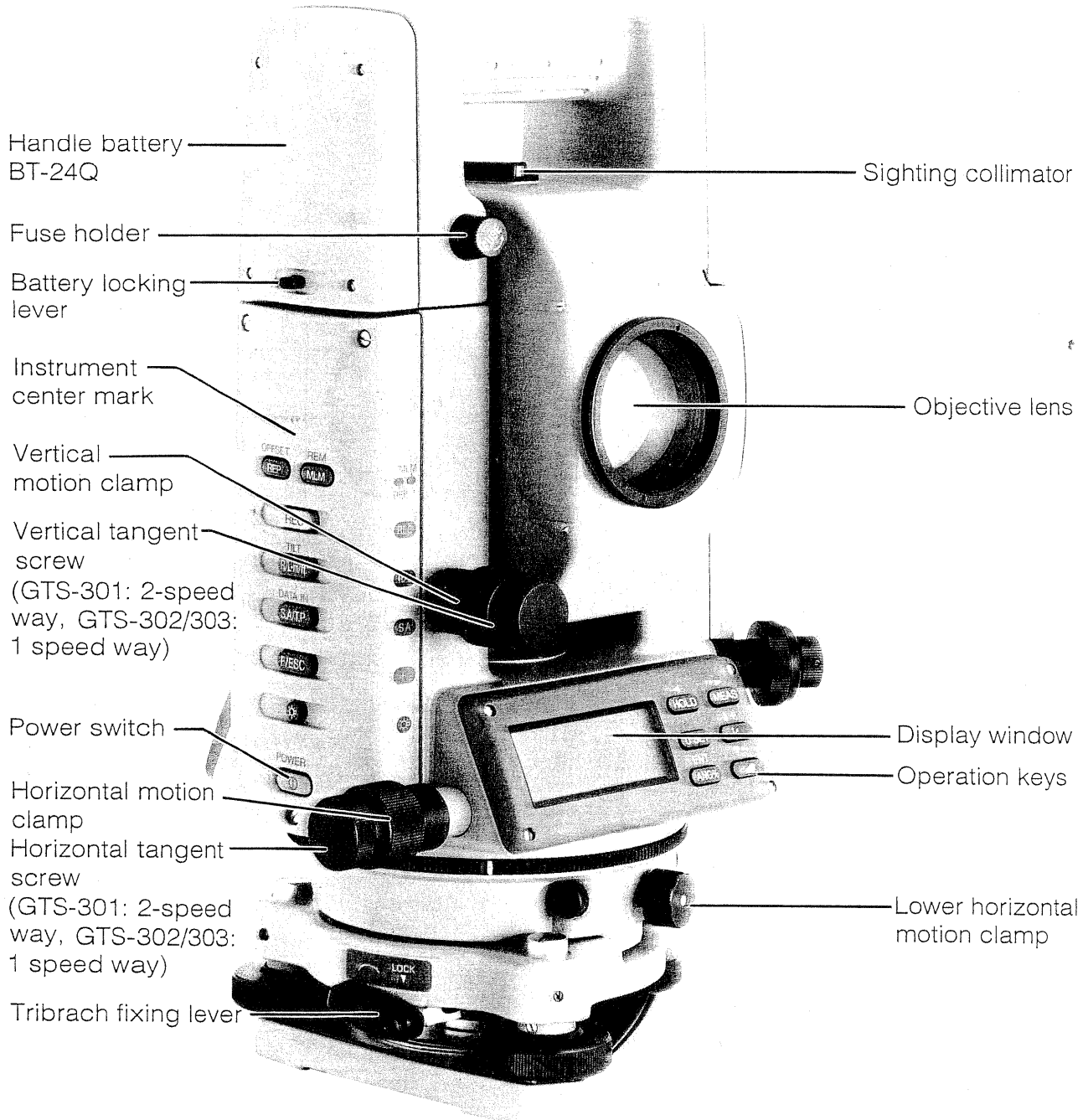

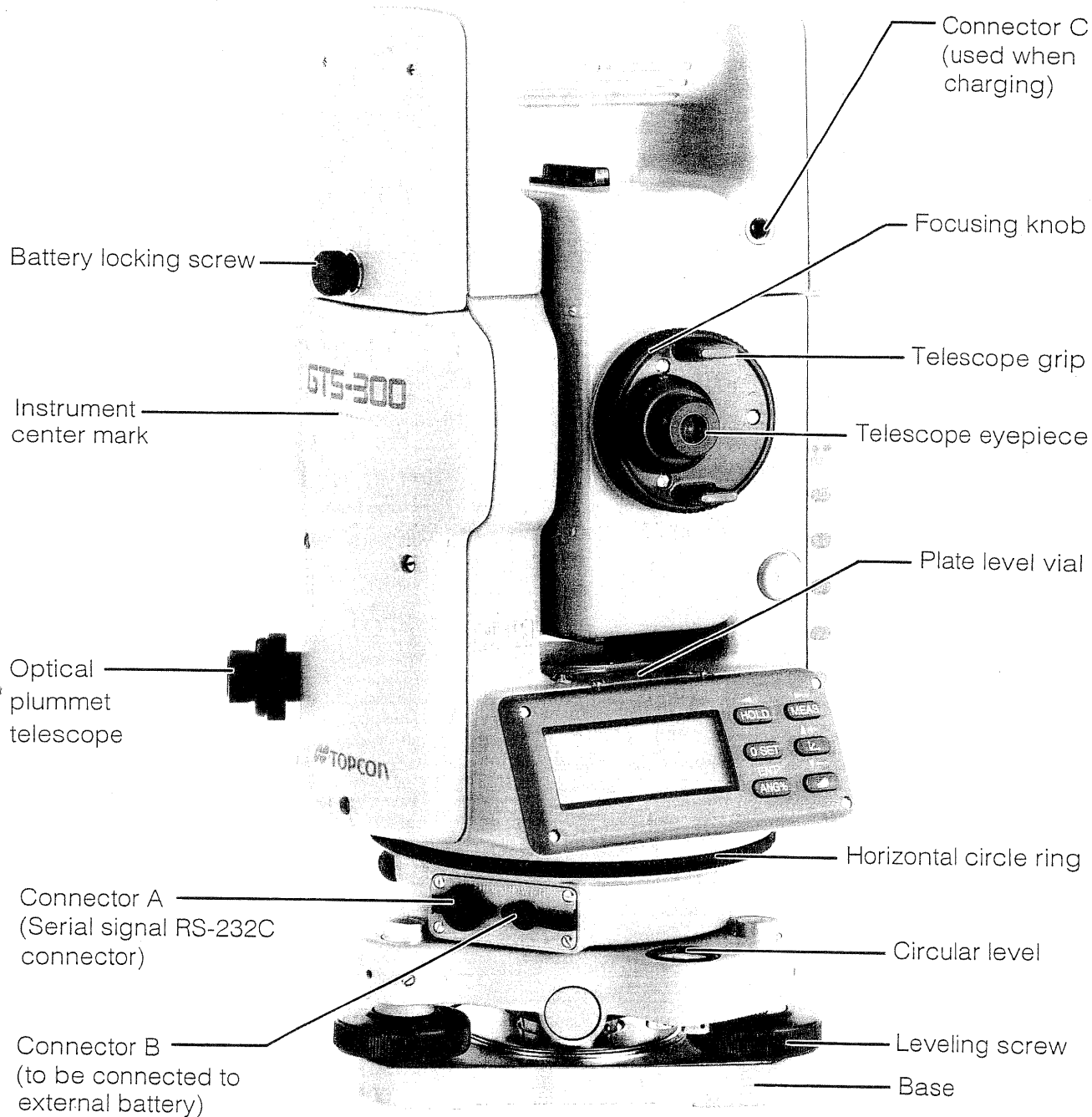

1.2 Display Marks

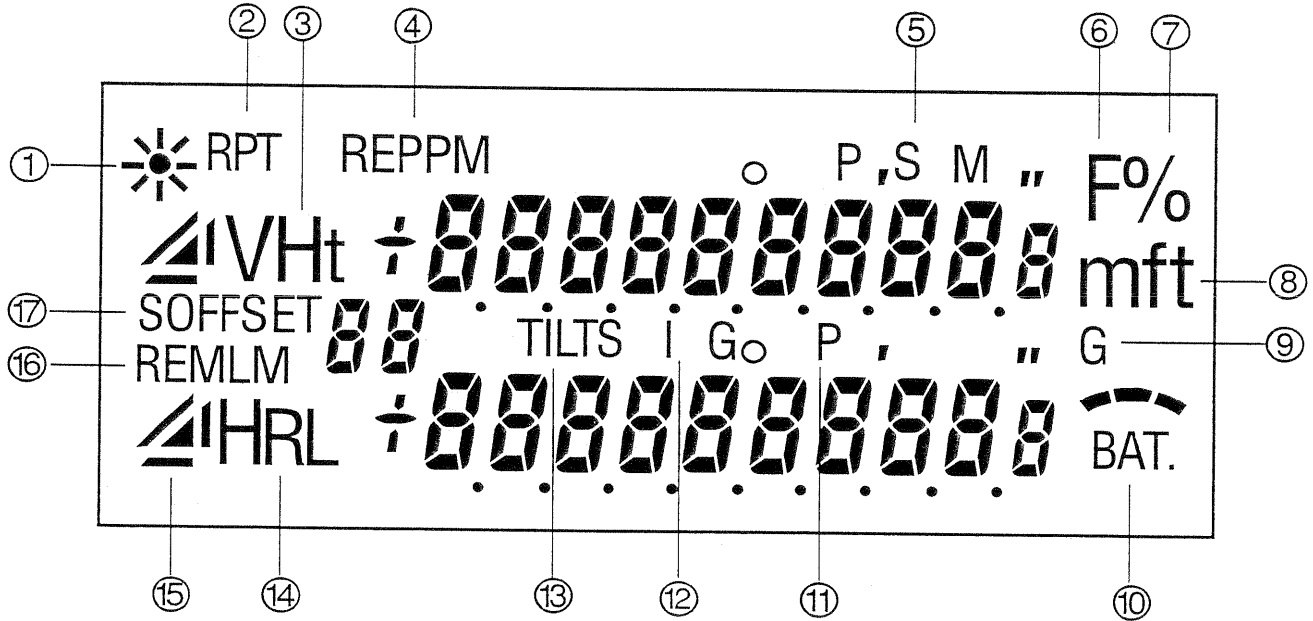

Display marks

- | | | |
|------|----------------|---|
| (1) | * | EDM working status (ON or OFF) |
| (2) | RPT | Continuous measurement (distance) |
| (3) | V | Vertical angle |
| | Ht | Total of repetition angle measurement |
| | H | Average of repetition angle measurement |
| (4) | REP | Repetition angle measurement |
| | PPM | Atmospheric correction value |
| (5) | PSM | Prism constant |
| (6) | F | Functioning status |
| (7) | % | Vertical angle in percentage |
| (8) | mft | Distance units |
| | | m...Meter |
| | | ft...Feet |
| (9) | G | Angle unit...GON |
| (10) | | Remaining battery capacity |
| (11) | P | Atmospheric pressure |
| (12) | SIG | Return signal level |
| (13) | TILT | Tilt working status |
| | T | Temperature |
| (14) | H _R | Horizontal angle right |
| | H _L | Horizontal angle left |
| (15) | | Horizontal distance |
| | | Relative elevation |
| | | Slope distance |
| | | Northing coordinate |
| | | Easting coordinate |
| | | Z coordinate |
| (16) | REM | Remote elevation measurement |
| | MLM | Missing line measurement |
| (17) | SO | Stake out |
| | OFFSET | Offset measurement |
| | SET | Setting numerals |

1.3 Operating Keys

•Main Keys

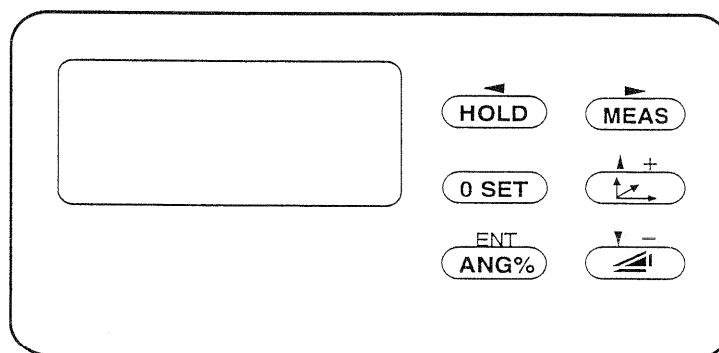

Key	Description	
	Holding the horizontal angle	Hold the horizontal angle by pressing the key once at the angle measurement mode. Measure from the held angle by pressing the key again.
	Horizontal angle 0° setting	Display horizontal angle 0°00'00" by pressing the key once at the angle measurement mode. Measure from 0°00'00" by pressing the key again.
	Angle measurement Display the angle in percent (Enter key)	Switch to the angle measurement mode from the mode for distance measurement or coordinates measurement. Switch the displayed angle in percent and vice versa when the vertical angle is displayed.
	Distance measurement	<ul style="list-style-type: none"> • Set to the N-time measurement at the normal measurement (FINE) mode or the coarse mode by pressing the key once. At this mode, the measurement is repeated N-times and the data displayed is held. • Set to the mode for tracking or coarse by pressing the key twice continuously.
	<ul style="list-style-type: none"> • Continuous measurement for coordinates • Switching to display N(X) and E(Y) coordinates/Z coordinate 	<ul style="list-style-type: none"> • Set to the coordinates measurement mode from the angle measurement mode by pressing the key once. • At the coordinates measurement mode, switch to display N(X)/E(Y) coordinates and Z coordinate each time pressing the key.
	Continuous measurement for distance Switching horizontal distance, relative elevation and slope distance	Switch to display horizontal distance, relative elevation and slope distance in sequence each time pressing the key.

•At the Data Input Mode and the Selecting Mode

Key	Description	
	Moving the blinking digit to the left	Move the blinking digit to set to the left at the data input and the selecting modes.
	Moving the blinking digit to the right	Move the blinking digit to set to the right at the data input and the selecting modes.
	Increasing the blinking numeral Setting (+) sign	Select the standard distance input for stake out at the data input mode. Increase the number of the blinking digit. Set (+) sign to the set value.
	Decreasing the blinking numeral Setting (-) sign	Select the coordinate value input of occupied point at the data input mode. Decrease the number of the blinking digit.

• Subkeys

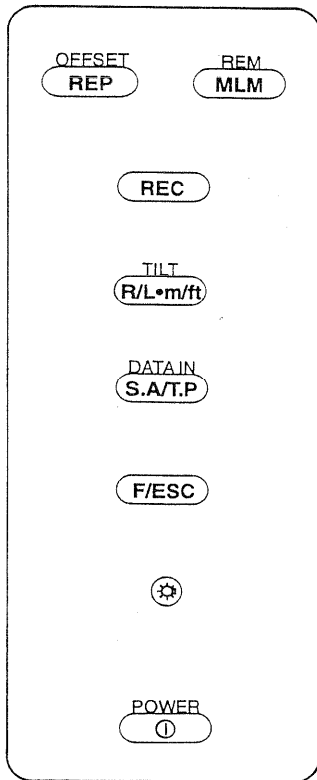

Key	Description	
OFFSET REP	Repetition angle measurement	Set to the repetition angle measurement mode. Return to the previous mode by pressing the F/ESC key.
REM MLM	Missing line measurement	Set to missing measurement. Select a mode for 2 missing line measurement modes. Return to the previous mode by pressing the F/ESC key.
REC	Record (Data output)	Start the measurement by pressing the key once and hold the data. Output the data by pressing the key again.
TILT R/L•m/ft	Switching horizontal angle right/left Switching meter/feet	Set the horizontal angle right mode to the horizontal left mode. Change the mode alternately each time pressing the key. At the distance mode, switch the distance unit meter to feet (when feet are set in the selecting mode).
DATA IN S.A/T.P	Set audio mode	Set to the set audio mode by pressing the key once. Display atmospheric correction value, prism constant and return signal level. Set to the input mode for atmospheric correction value and prism constant by pressing the key again.
F/ESC	Function key Escape key	Function the keys in upper rows. Escape from the setting mode.
⊗	Illumination key	illuminate the cross hairs and the display window.
POWER ①	Power switch	Turn the instrument ON and OFF.



• Functioning Status

Key in the Upper Row	Description	
OFFSET	Offset measurement mode	Set to the offset measurement mode. Get coordinate values when it is difficult to set up the prism such as the center of a tree, etc.
REM	Remote elevation measurement	Set to the remote elevation measurement mode. Get vertical distance when it is difficult to set up the prism such as a building, etc.
TILT	Displaying tilt	When setting the automatic correction for vertical angle, display the automatic correction value.
DATA IN	Data input	Enter the standard distance for stake out or the coordinate values for occupied point.

1.4 Data Output [REC]

Result of measurement is transferred to TOPCON FC series Data Collector from the Instrument. If you press the **REC** key once, the measurement is started and the new data is held. If you press the key again, the data is transferred to the data collector. If you press the **REC** key twice continuously, the data transferred directly.

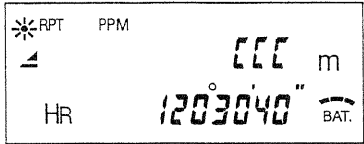
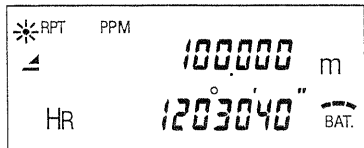
<Example> In the distance measurement mode

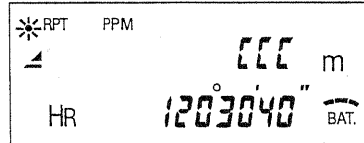
Operating Procedure	Key Operation	Display
<p>① Press the REC key. The measurement is started.</p> <p>The measurement result is held and shown with blink.</p> <ul style="list-style-type: none"> If you press any key except the REC and the \odot keys, the held measurement result is canceled and the operation will return to the distance measurement mode. 		 <p style="text-align: center;">↓</p> 
<p>② Transfer to the data collector.</p> <p>The operation will automatically return to the distance measurement mode.</p>		

The following data will be output at each mode.

Mode	Output
Angle mode (V, HR or HL) (V in percent)	V, HR (or HL)
Horizontal distance mode (HR, HD, VD)	V, HR, \triangle , \triangleleft
Slope distance mode (V, HR, SD)	V, HR, \triangle , \triangleleft
Coordinate mode	N, E, Z, HR

- Output at the offset measurement mode is the same as the contents above.
- The display and the output at the coarse mode are the same as the contents above.
- Output at the tracking mode is displayed the distance data only (\triangle , \triangleleft or \triangleleft).

• Serial signal RS-232C connector

Serial signal connector is used for connecting the GTS-300 series with a computer, which enables the computer to receive measured data from the GTS-300 series or to send pre-set data to it.

The details necessary for the connection with the GTS-300 series are obtained from its Interface Manual which is optionally available. Please refer to the manual.

2. PREPARATIONS FOR MEASUREMENT

2.1 Power Connection

(unnecessary if handle battery BT-24Q is used.)

See below for connecting the external battery pack.

• Battery pack BT-3Q

Power cord PC-5 is used.

(PC-6 can also be used if FC series are not connected.)

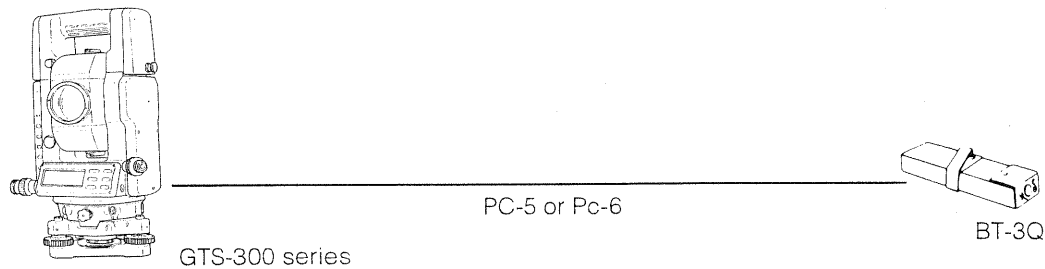

• Large capacity battery pack BT-3L

Power cord PC-6 is used.

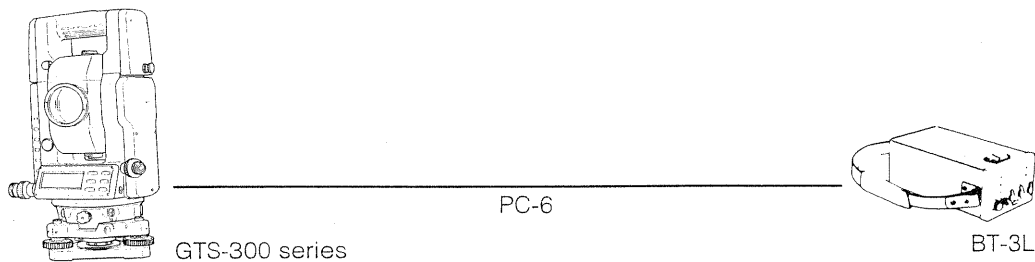

Connector ends of the power cords , PC-5 and PC-6 are as follows:

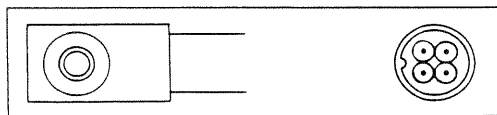

PC-5

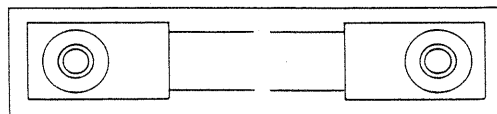

PC-6

Note: Always remove the handle battery or switch off the instrument when any external power supply is used. If used together, battery life may be shortened or a fuse may blow.

2.2 Leveling the Instrument

Level and center the instrument correctly to insure the best performance.

Use tripods with a tripod screw of 5/8 in. diameter and 11 threads per inch, such as the Type E TOPCON wide-frame wooden tripod.

Leveling and Centering the Instrument (Reference)

1. Setting up the Tripod

Since the range in which the instrument can slide on the tripod head is about 2cm in radius, set up the tripod so that the center of the tripod head can be in the said range and can be roughly horizontal by using the plumb bob if required.

- ① To set up the tripod, position the two legs first, and then position the remaining one leg, moving left and right, to place the tripod head's left and right directions horizontally. Next, place the tripod head horizontally moving the said leg back and forth. If the instrument has been roughly centered, fix the legs. The easiest way to place the tripod head horizontally is to fix the length of any leg among the three legs and adjust the other two by enlarging or reducing their lengths.
- ② Firmly fix three legs by stamping on them so that they will not move.
- ③ If the tripod head is roughly placed in horizontal and its center is within the proper range, tighten the fixing screws of each leg firmly so that the legs and the tripod head will not move during the surveying.

2. Installing the Instrument on the Tripod Head

Place the instrument on the tripod head and slide the instrument by loosening the tripod screw. If the plumb bob is positioned right over the center of the point, slightly tighten the tripod screw.

3. Roughly Leveling the Instrument by using the Circular Level

- ① Turn the leveling screws A and B to bring the bubble on or beneath the circle of the circular level.

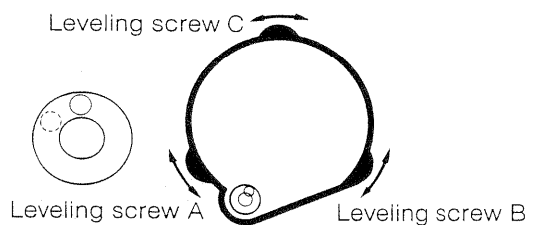

- ② Turn the leveling screw C to bring the bubble to the center of the circular level.

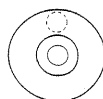

4. Centering by Using the Plate Level Vial

- ① Plate level vial parallel with the line connecting leveling screws A and B, and then bring the bubble to the center of the plate level vial by turning leveling screws A and B.

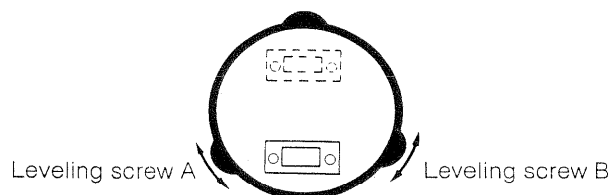

- ② Rotate the instrument 90°(100gon) around its vertical axis and turn the remaining leveling screw or C to center the bubble once more.

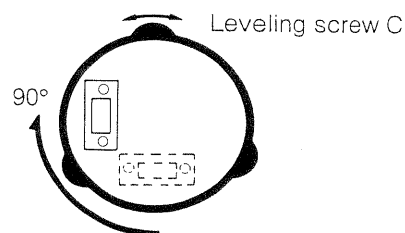

- ③ Repeat the procedures ① and ② for each 90°(100gon) rotation of the instrument and check whether the bubble is correctly centered for all four points.

5. Centering by Using the Optical Plummet Telescope

Adjust the eyepiece of the optical plummet telescope to your eyesight.

Slide the instrument by loosening the tripod screw, place the point on the center mark, and then tighten the tripod screw. Sliding the instrument carefully not to rotate that allows you to get the least dislocation of the bubble.

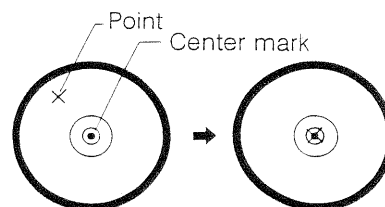

6. Completely Leveling the Instrument

Leveling the instrument precisely in the similar way to 4. Rotate the instrument and check to see that the bubble is in the center of the circular level regardless of telescope direction, then tighten the tripod screw hard.

2.3 Power Switch ON

① Turn the power switch ON

All segments are shown for about 2 seconds before the vertical angle 0° setting request is shown.

- Check the battery capacity at this time. Refer to "2.4 Remaining Battery Capacity".

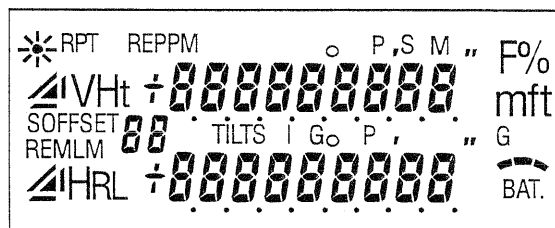

All segments

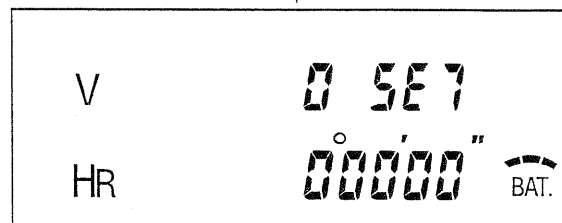

Telescope rotation

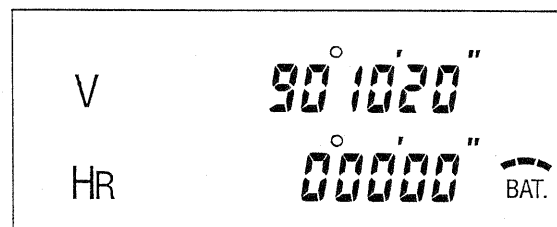

② Rotate the telescope to set the instrument at a vertical angle reading of 0°.

Angle mode is shown.

- The mode when the power is on can be set to the distance measurement mode. Refer to "14. SELECTING MODE".
- When you set the horizontal angle at 0° (horizontal angle 0° detection in the selecting mode), set the horizontal angle 0° setting by rotating the instrument.

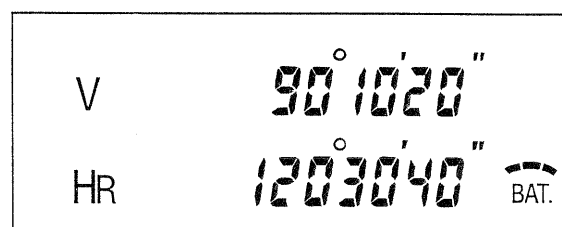
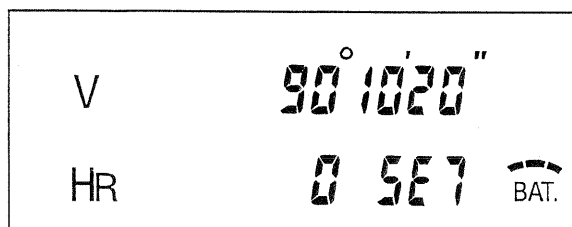



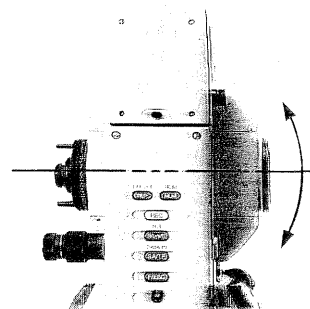



Note: For setting the vertical angle at 0°, a datum 0 is provided on the vertical angle scale circumference. If the datum 0 passes the sensor by rotating the telescope, angle measurement begins. Since the datum 0 is placed near the level position of the normal telescope setting, the vertical angle 0° setting can easily be set by rotating the telescope near the level position.

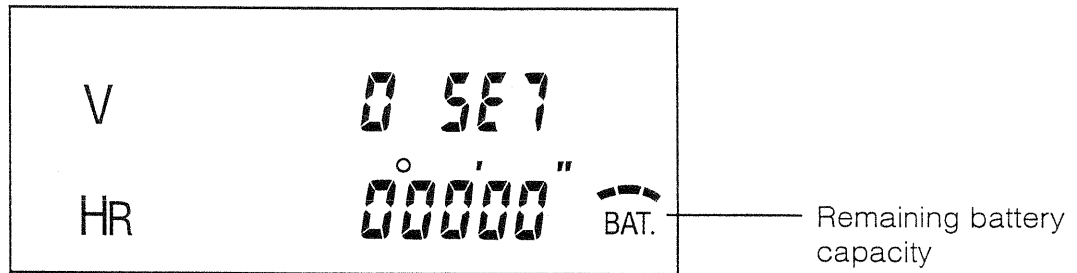

2.4 Remaining Battery Capacity

Confirm the remaining battery (internal) capacity by the display as shown below:



-  BAT. The power is full.
-  BAT. The power is sufficient.
-  BAT. The power is still sufficient, but it is recommended to prepare a spare battery or recharge the battery.
-  BAT. The power is poor. The battery should be recharged or replace the battery.
-  -BAT.-
(Blink) Measurement is impossible. Need to recharge or replace the battery.

- The battery operating time will vary depending on the environmental conditions as an ambient temperature, charging time, the number of times of charging and discharging etc. It is recommended for safety to charge the battery beforehand or to prepare spare full-charged batteries to go out with.
- The display of remaining battery capacity shows the battery power level at its mode. The safety condition indicated in the angle measurement mode does not necessarily assure the battery's ability to be used in the distance measurement mode. It may happen that the mode change from the angle mode to the distance mode will stop the operation because of the sufficiency of the battery power for the distance mode which consumes more power than the angle mode.
- Note that the EDM unit is working when "0° setting" at the power on, which shows as an easy battery check before use.
- Refer to "9. POWER SOURCE AND CHARGING".
- Since the display above shows the remaining internal battery capacity, you cannot confirm the remaining external battery capacity when using the external battery.

2.5 Tilt Correction

(GTS-301D/302D/303D have dual axes tilt sensor, GTS-303 has vertical tilt sensor only.)

Angle is corrected automatically by the tilt sensor. When angle is out of the correction range, the letter "b" is shown. Level the instrument by using leveling screw.

● Dual axes tilt sensor mode (GTS-301D/302D/303D).

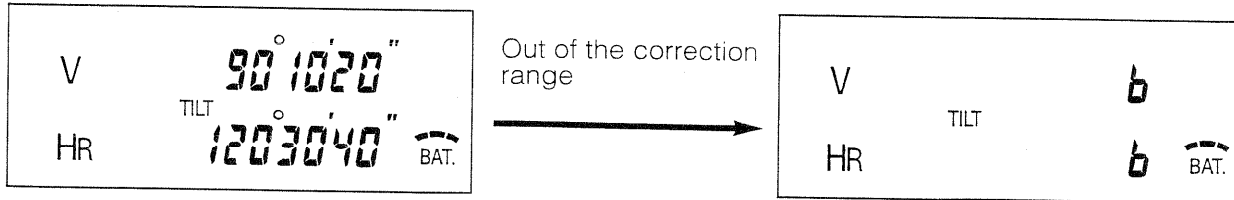

Showing automatically corrected value on the display window.

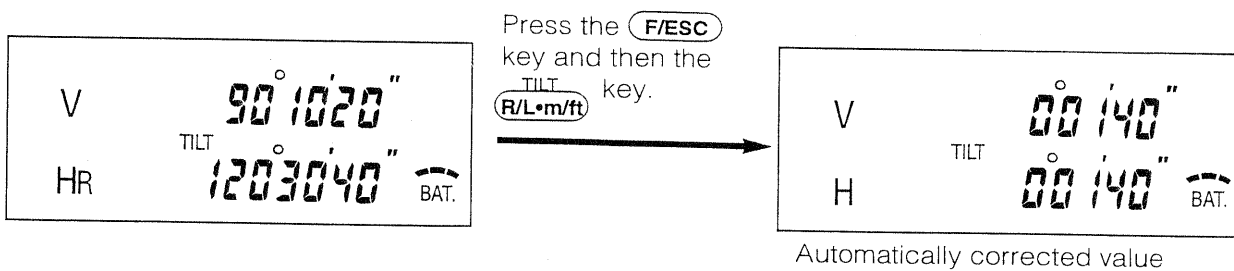

● GTS-303, Vertical tilt sensor mode (GTS-301D/302D/303D).

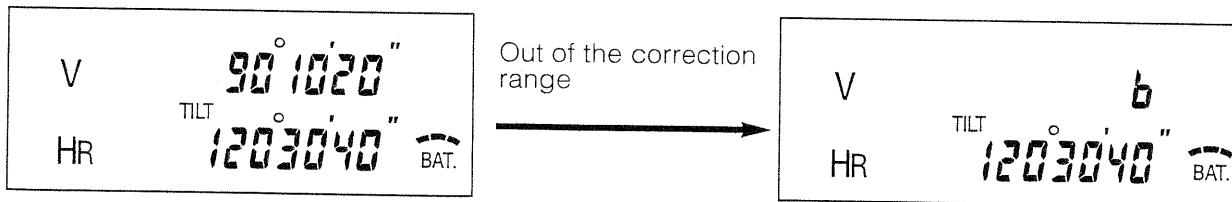

Showing automatically corrected value on the display window.

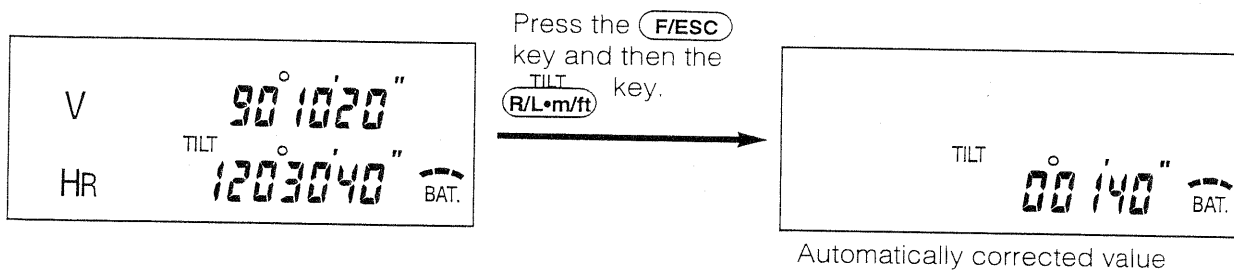



- 1) To stop the tilt correction, refer to "14 SELECTING MODE".
- 2) To change the tilt sensor mode (GTS-301D/302D/303D only), refer to "14 SELECTING MODE".

3. ANGLE MEASUREMENT

3.1 Measuring a Horizontal Angle Right and a Vertical Angle

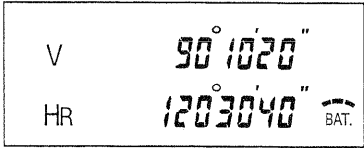
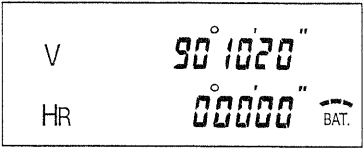
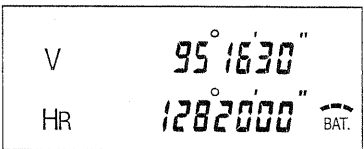
Confirm that you are in the angle measurement mode (V,HR).

Operating Procedure	Key Operation	Display
① Collimate the first target A.		
② Set the horizontal angle of target A at 0°00'00". (Horizontal angle 0° setting)	<input type="button" value="0 SET"/> <input type="button" value="0 SET"/>	
③ Collimate the second target B. The horizontal and vertical angle of unknown point B is shown.		
<ul style="list-style-type: none"> To release 0° setting after pressing the <input type="button" value="0 SET"/> key (display of 0°00'00" blinks), press any key except the <input type="button" value="0 SET"/> and the  keys. If you press the <input type="button" value="ENT"/> <input type="button" value="ANG%"/> key, the displayed unit of vertical angle is switched to percent. 		

Reference

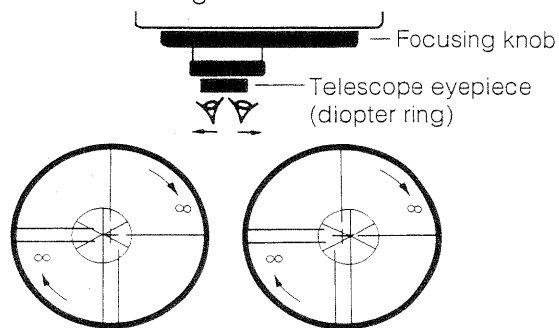

How to collimate

- Point the telescope toward the light. Turn the diopter ring and adjust the diopter so that the cross hairs are clearly observed. (Turn the diopter ring toward you first and then backward to focus.)
 - Loosen the clamp screws, and observe the target at the peak of the triangle mark of the collimator. Allow a certain space between the collimator and yourself for collimating.
 - Tighten each tangent screws and focus the target with the focusing knob.
 - Turn the tangent screws to bring the cross hairs to the target center.
- If parallax is created between the prism and the target (within 5m) when viewing vertically or horizontally while looking into the telescope, focusing is incorrect or diopter adjustment is poor. This adversely affects precision in measurement or survey. Eliminate the parallax by careful focusing and diopter adjustment.





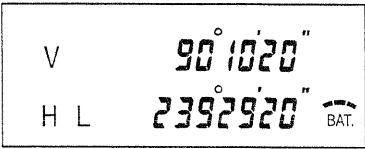



3.2 Measuring a Horizontal Angle Left

Confirm that you are in the angle right measurement mode.

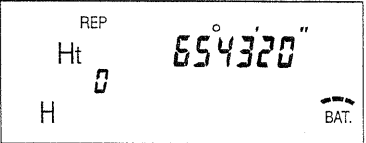
Operating Procedure	Key Operation	Display
<p>① Change the mode from horizontal angle right (HR) to horizontal angle left (HL).</p> <p>② For further operations, follow "3.1 Measuring a Horizontal Angle Right and a Vertical Angle".</p>		
<p>• Press the  key once again to return from the horizontal angle left (HL) mode to the normal horizontal right (HR) mode.</p>		

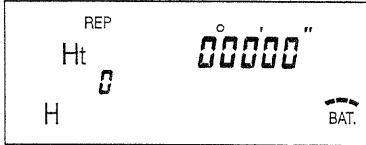
3.3 Measuring a Repetition Angle

Operating Procedure	Key Operation	Display
<p>① Set the instrument to the repetition angle measurement mode.</p>		
<p>② Collimate the first target A.</p>		
<p>③ Set the horizontal angle of target A at 0°00'00".</p>	 	
<p>④ Use the horizontal motion clamp and the horizontal tangent screw to collimate the second target B.</p>		

- ⑤ Hold and store the measured horizontal angle in the instrument.
- ⑥ Recollimate the first target A using the horizontal motion clamp and the horizontal tangent screw.
- ⑦ Press the **MEAS** key.
- ⑧ Collimate the second target B using the horizontal motion clamp and the horizontal tangent screw.
- ⑨ Hold and store the measured horizontal angle in the instrument. The doubled of angle and the average of angle are shown.
- ⑩ Repeat ⑥ to ⑨ to measure the desired number of repetition.

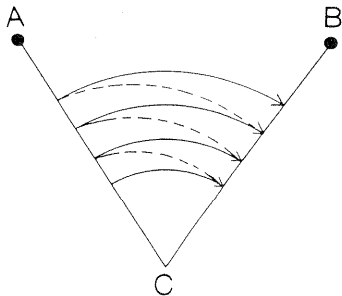

HOLD

REP		
Ht	130°25'20"	
H	130°25'20"	BAT.

MEAS

REP		
Ht	260°50'40"	
H	130°25'20"	BAT.

HOLD

REP		
Ht	260°50'40"	
H	130°25'20"	BAT.

Doubled angle







REP		
Ht	52°14'120"	
H	130°25'20"	BAT.

Quadrupled angle

- In the repetition angle mode, horizontal angle can be accumulated up to [3600°00'00" – minimum reading] or [3600°00'00" – minimum reading] (horizontal angle left). In the case of 5 seconds reading, horizontal angle can be accumulated up to ±3599°59'55".
- To begin the repetition angle measurement again, start from the procedure ②, the first target collimation.
- To return to the previous mode from the repetition angle measurement mode, press the **F/ESC** key.
- If you do not need the result of average of angle, skip the **HOLD** Key operation of the procedures ⑤ and ⑧.

3.4 Setting a Required Horizontal Angle

Confirm that you are in the angle right measurement mode.

Operating Procedure	Key Operation	Display
<p>① Set the required horizontal angle using horizontal tangent screw.</p> <p>② Hold the horizontal angle. The mark "HR" or "HL" blinks and the horizontal angle will be held.</p> <ul style="list-style-type: none"> To return to the angle status before the data is held, press any key except the HOLD and the  keys. <p>③ Collimate the target to set.</p> <p>④ Complete holding the horizontal angle. The measurement will start from the held angle.</p>	<p></p> <p></p>	  

4. DISTANCE MEASUREMENT

4.1 Setting the Atmospheric Correction Value

When setting the atmospheric correction value, obtain the correction value by measuring the temperature and atmospheric pressure. Refer to "12. ATMOSPHERIC CORRECTION AND PRISM CONSTANT" to obtain and set the atmospheric correction value.



- It has been set at 15°C and 760 mmHg (0 ppm) at the factory.

4.2 Setting the Prism Constant

When using prism reflectors other than TOPCON, the offset compensation factor may need to be adjusted. Refer to "12. ATMOSPHERIC CORRECTION AND PRISM CONSTANT" to set the offset compensation factor.

4.3 Measuring the Distance (Continuous Measurement)

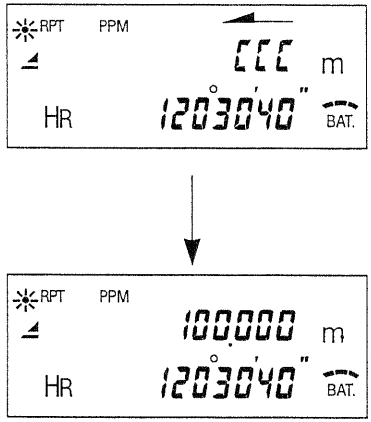
Confirm that you are in the angle measurement mode.

Operating Procedure	Key Operation	Display
<p>① Sight the center of the prism.</p> <p>② Set the instrument to the continuous measurement mode (distance measurement) to start automatic distance measurement.</p> <ul style="list-style-type: none"> • When EDM is working, the mark "*" lights up. <p>The measurement results are shown.</p> <ul style="list-style-type: none"> • The mark "m" with a buzzer sound lights up and goes off alternately each time the measurement results are shown. 		<p>Measuring status</p> 
<ul style="list-style-type: none"> • To show relative elevation or slope distance, press the  key once or twice. Horizontal distance, relative elevation and slope distance will be shown in sequence each time pressing the key. • Measurement may be repeated automatically in the instrument if the result is affected by shimmer, etc. • To return to the angle measurement mode, press the  key. • " - E " is shown when the light is poor. 		

4.4 Measuring the Distance (N-time Measurement/Single Measurement)

When presetting the number of times, GTS-300 series measure the distance as the setting times and display the average distance.

When presetting the number of times as 1, the average distance is not displayed because of single measurement. It has been set at single measurement at the factory.

For setting the number of times (N times) in the distance measurement, see "14.2.3 How to set N-time distance measurement" on page 53.

At the N-time measurement, you can select a measurement mode either the normal measurement mode (FINE) or the coarse mode (CRS). Set by digit number 8 of selecting mode 3.

Confirm that you are in the angle measurement mode.

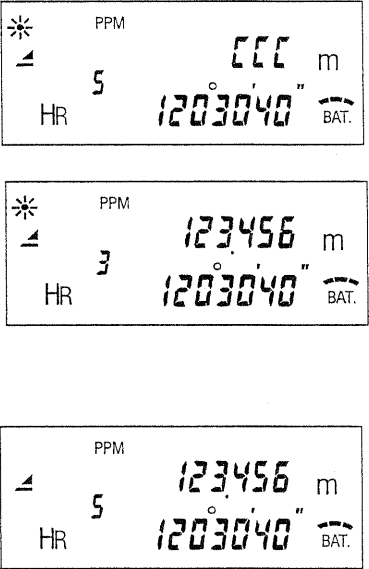
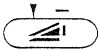
Operating Procedure	Key Operation	Display
<p>① Sight the center of the prism.</p> <p>② Set the instrument to the number of distance measurement mode. The distance measurement will be started.</p> <p>Results of N-time measurement are shown.</p> <ul style="list-style-type: none"> The mark "m" with a buzzer sound lights up and goes off alternately each time the measurement results are shown. <p>The average value is displayed and held followingly with buzzer sound and the mark "*" goes off.</p>		 <p>Example: Results of 5-time measurement</p>
<ul style="list-style-type: none"> You can set the number of times 1 to 99. When you change the mode for N-time measurement to continuous measurement, press the  key after setting the mode to angle measurement or set audio. 		









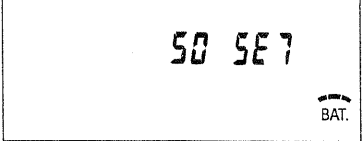

4.5 Stake out (SO)

The difference between the measured distance and the standard distance by presetting the standard distance is displayed.

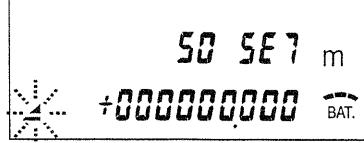
Measured distance – Standard (Preset) distance = Displayed value

- In stake-out operation, you can select one measurement among horizontal distance (\triangleleft), relative elevation (\triangleup) and slope distance (\triangle).

Setting standard distance (Example standard distance 72.0m)

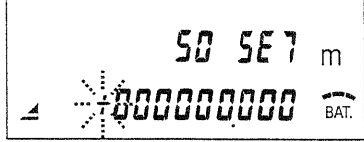
Operating Procedure	Key Operation	Display
① Set to the key functioning status.		
② Set to the data input mode.		
③ Confirm that the standard distance input display for stake out is shown. Press the  key. The previous input value is shown.		 <p>Blink</p>
④ Select one measurement among horizontal distance (\triangleleft), relative elevation (\triangleup) and slope distance (\triangle). Each time pressing the  key, horizontal distance (\triangleleft), relative elevation (\triangleup) and slope distance (\triangle) are shown in sequence.		
⑤ Complete selecting measurement by pressing  key. Now, the sign blinks.		
 key: Set "+" sign.		
 key: Set "-" sign.		

⑥ Enter the standard distance.

 key: Blinking digit moves to the right.

 key: Blinking digit moves to the left.

 key: The numerical value of the blinking digit increases.

 key: The numerical value of the blinking digit decreases.

[Example]

Enter the standard distance 72.0m in the status of no previous input value.

1) Blink the position of the second of tens.

2) Set 7 to the position of the second of tens.

3) Blink the position of units.

4) Set 2 to the position of units.

⑦ Press the  key.

⑧ Press the  key.
The operation will return to the mode before setting the standard distance.

 key
Press 5 times.

 key
Press 7 times.

 key
Press once.

 key
Press twice.

 key

 key









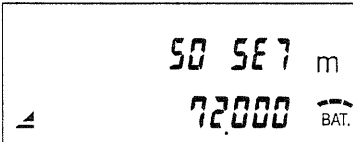

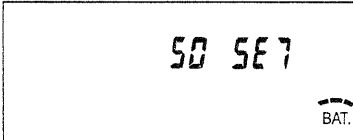





- To reset the normal distance measurement (the standard distance to "0m", 0m can be set quickly by pressing the  key in procedure ⑤.

Confirm that you are in the mode for angle measurement or distance measurement.

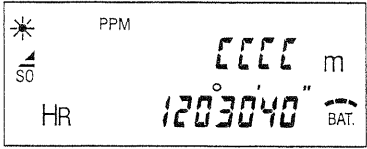
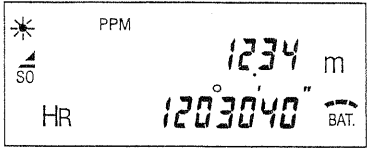
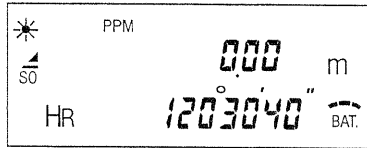
Operating Procedure	Key Operation	Display
<p>① Sight the center of the prism.</p> <p>② Set to the mode for tracking or coarse.</p> <p>The measurement is started and the difference from the standard distance is shown.</p> <ul style="list-style-type: none"> • When you set the standard distance in relative elevation or slope distance, press the  key. • "SO" will be shown when the standard distance is set. <p>③ Move the target until the difference from the standard distance becomes 0m.</p>	<p></p> <p></p>	  
<ul style="list-style-type: none"> • To return to the normal distance measurement mode, reset the standard distance to "0" or turn the power OFF. • Stake out can be operated in the same way in the continuous measurement mode and single measurement mode. 		

- **Data input mode**

You will be in the data input mode by pressing the **F/ESC** key and **DATA IN S.A/T.P** key. In the data input mode, you can set standard distance for stake out, coordinate values of occupied point and instrument height/prism height (see "6. COORDINATES MEASUREMENT").

- **Data input mode operation**

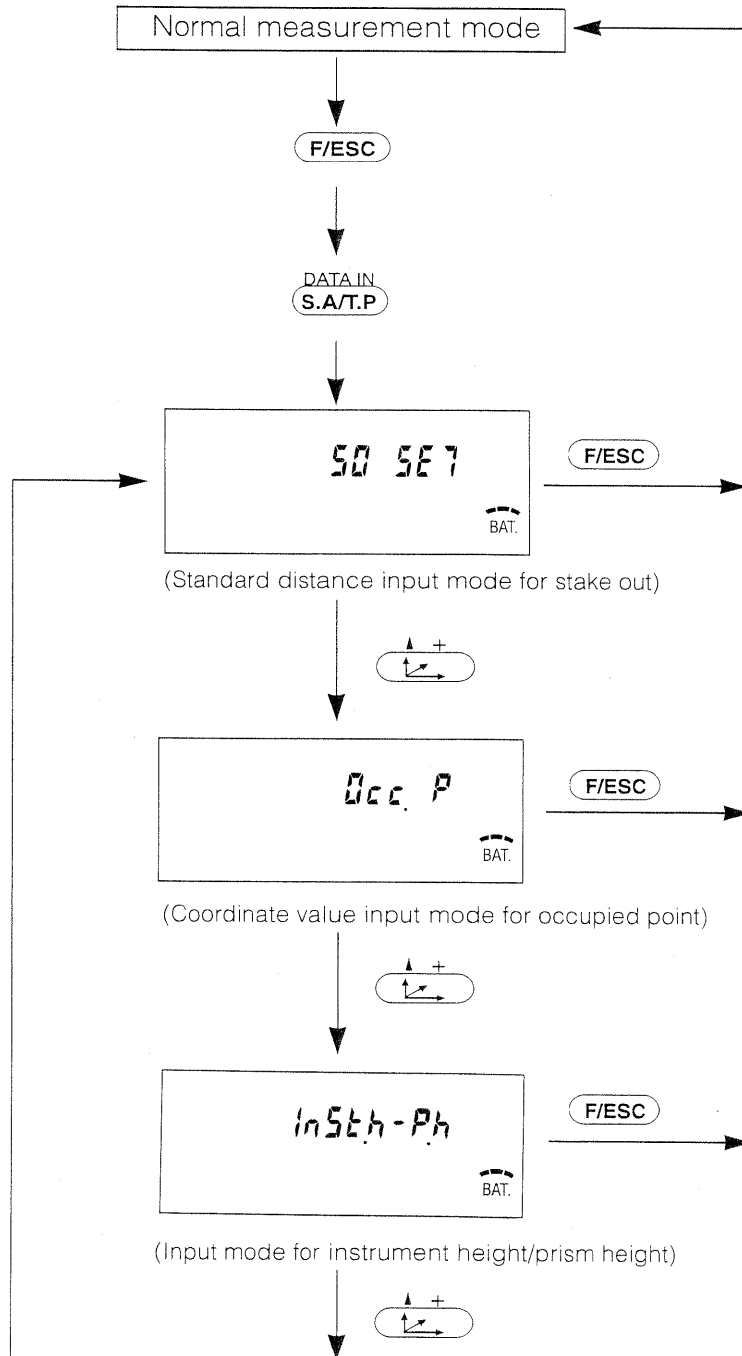

- Your selected mode is decided by pressing the **ENT ANG%** key after selecting the standard distance input mode for stake out, the coordinate value input mode for occupied point or the instrument height/prism height input mode.





5. TRACKING AND COARSE MEASUREMENTS

Tracking and coarse measurements take shorter time than normal measurement. Results of repeated measurement are shown every 0.5 seconds. The minimum display is 1 cm (0.02 ft).

The tracking mode is very useful when tailing the moving object or carrying out stake-out work. Function of coarse mode is the same as that of tracking mode except displaying and outputting items.

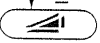
Regarding switching from tracking to coarse mode or vice versa, see "14. SELECTING MODE".

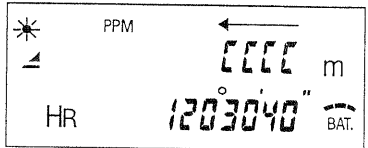
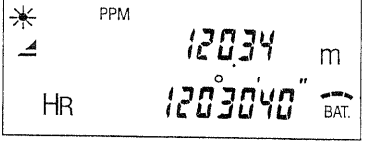
Confirm that you are in the angle measurement mode.











Operating Procedure	Key Operation	Display
<p>① Sight the center of the prism.</p> <p>② Set to the mode for tracking or coarse.</p> <p>Horizontal distance measurement is started automatically.</p> <ul style="list-style-type: none"> To measure the relative elevation (Δ) and slope distance (Δ), press the  key. 	<p></p> <p></p>	<p>Measuring status</p>  <p>↓</p> 
<ul style="list-style-type: none"> To return to the continuous measurement mode for distance from the tracking measurement mode, press the  key after returning to the angle measurement mode by pressing the  key. Only the distance data shown is output in the tracking measurement mode. Output contents as shown below in the coarse measurement mode are the same as that of in the continuous measurement mode for distance. <p>Modes of horizontal distance and relative elevation: V, HR, Δ, Δ</p> <p>Slope distance mode: V, HR, Δ, Δ</p>		

6. COORDINATES MEASUREMENT

6.1 Setting Coordinate Values of Occupied Point (OCC. POINT)

Set the coordinates of instrument (occupied point) according to coordinate origin, and instrument automatically convert and display the unknown point (prism point) coordinates following the origin.

It is possible to retain the coordinates of occupied point after turning the power switch off. For setting, see "14. SELECTING MODE".

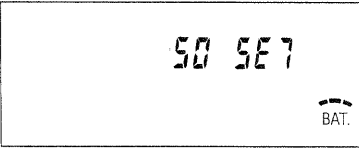
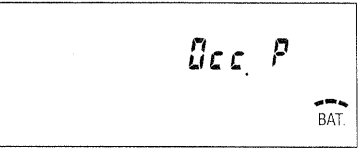
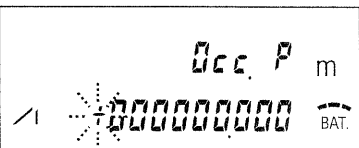
Operating Procedure	Key Operation	Display
<p>① Set to the key functioning status.</p> <p>② Set to the data input mode.</p> <p>③ Set to the coordinate value input mode.</p> <p>④ Confirm that the coordinate value input display is shown. Press the  key.</p> <p>The previous input value is shown and its sign blinks.</p> <p>⑤ Enter N(X) coordinate value.</p> <p> key: Set "+" sign.</p> <p> key: Set "-" sign.</p> <p> key: Blinking digit moves to the right.</p> <p> key: Blinking digit moves to the left.</p> <p> key: The numerical value of the blinking digit increases.</p> <p> key: The numerical value of the blinking digit decreases.</p>	<p></p> <p></p> <p></p> <p></p>	<p></p> <p></p> <p></p>

[Example]

Enter N(X) coordinate value 72.0m in the status of no previous input value.

- 1) Blink the position of the second of tens.
- 2) Set 7 to the position of the second of tens.
- 3) Blink the position of units.
- 4) Set 2 to the position of units.

⑥ Press the  key.

⑦ Enter E(Y) and Z coordinate values in the same manner.

⑧ Press the  key.
The operation will return to the mode before entering the coordinate values.



Press 5 times.

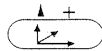

Press 7 times.



Press once.

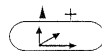



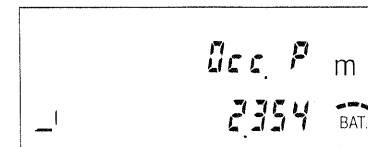
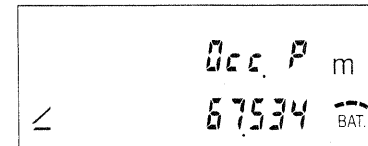
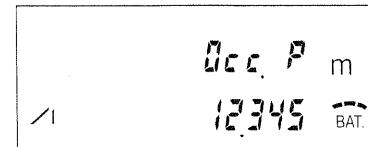
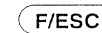









Press twice



6.2 How to enter the instrument height/prism height

Measure the coordinates by entering the instrument height/prism height, coordinates of unknown point will be measured directly.

- Set values of the instrument height/prism height will be erased when switching the power OFF.

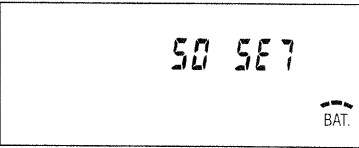
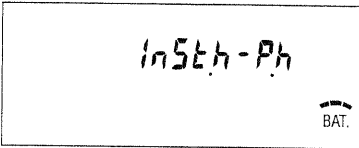
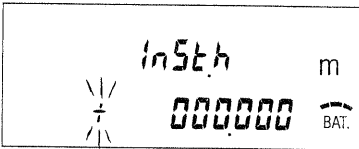
Operating Procedure	Key Operation	Display
<p>① Set to the key function status.</p> <p>② Set to the data input mode.</p> <p>③ Set to the instrument height/prism height input mode.</p> <p>④ Confirm that the instrument height/prism height input display is shown. Press the  ANG% key.</p> <p>The previous input value is shown and its sign blinks.</p> <p>⑤ Enter the instrument height.</p> <p> key: Set "+" sign.</p> <p> key: Set "-" sign.</p> <p> key: Blinks digit moves to the right.</p> <p> key: Blinks digit moves to the left.</p> <p> key: The numerical value of the blinking digit increases.</p> <p> key: The numerical value of the blinking digit decreases.</p>	<p></p> <p></p> <p></p> <p></p> <p></p>	<p></p> <p></p> <p></p>

[Example]

When entering the instrument height of +1.5m:

1) Confirm that the sign "+" is blinking and blink the position of units.

2) Set 1 to the position of units.

3) Blink the place of tenth.

4) Set 5 to the place of tenth.

⑥ Press the  key.

The prism height input display will be shown.

⑦ Enter the prism height in the same manner.

⑧ Press the  key.

The operation will return to the instrument input display.

⑨ Press the  key.

The operation will return to the mode before entering the instrument height/prism height.

 Press 3 times.

 Press once.

 Press once.

 Press 5 times.



Enter prism height.





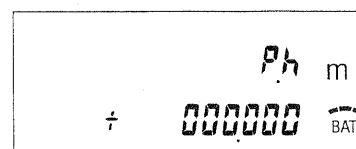
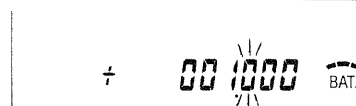
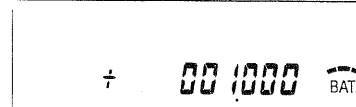
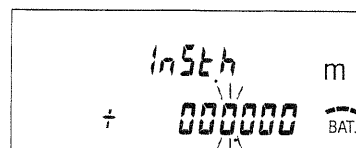

6.3 3-dimensional coordinate measurement (Measuring by entering instrument height/prism height)

Measure the coordinates by entering the instrument height/prism height, coordinates of unknown point will be measured directly.

- When setting coordinate values of occupied point, see "6.1 Setting Coordinate Values of Occupied Point (OCC. POINT)".

- The coordinates of unknown point are calculated as shown below and displayed:

Coordinates of occupied point : (X_0, Y_0, H_0)

Instrument height : $Inst.h$

Prism height : $P.h$

Vertical distance (Relative elevation) : h

Coordinates of the center of the prism,
originated from the center point of the instrument : (x, y, h)

Coordinates of unknown point : (X_1, Y_1, H_1)



$X_1 = X_0 + x$

$Y_1 = Y_0 + y$

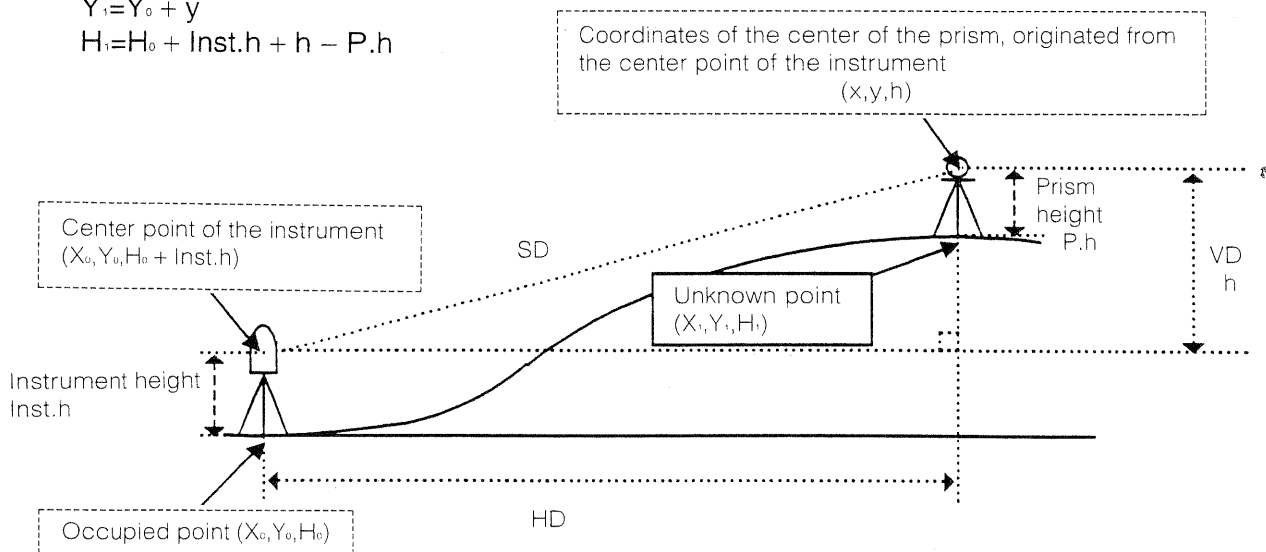
$H_1 = H_0 + Inst.h + h - P.h$

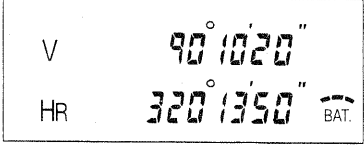
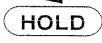
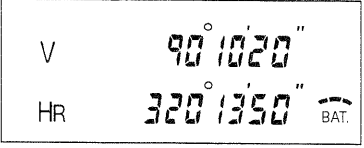

Confirm that you are in the angle measurement mode.

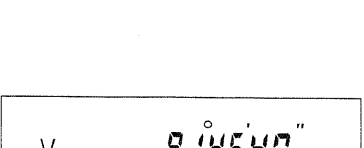
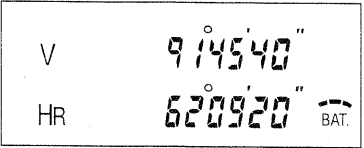
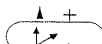
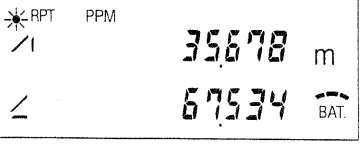
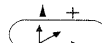
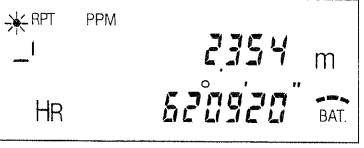
Operating Procedure	Key Operation	Display
① Show the direction angle of known point A with the horizontal tangent screw.		
② Hold the direction angle of known point A.		
③ Collimate known point A and complete holding its direction angle.		
④ Collimate unknown point B with the horizontal tangent screw and the vertical tangent screw.		
⑤ N(X) coordinate and E(Y) coordinate of unknown point B is measured continuously.		
⑥ Z coordinate of unknown point B is measured continuously.		
<ul style="list-style-type: none"> • If you press the MEAS key once during coordinate measurement, you are in the N-time measurement for coordinates measurement. If you press twice, you are in the mode for coarse or tracking for coordinates measurement. • To return to the normal angle measurement mode, press the ENT ANG% key. 		

7. SPECIAL MODE

7.1 Remote Elevation Measurement (REM)

To obtain elevation of the point at which setting the target prism is impossible, place the prism at any point on the vertical line from the target then carry out REM procedure as follows.

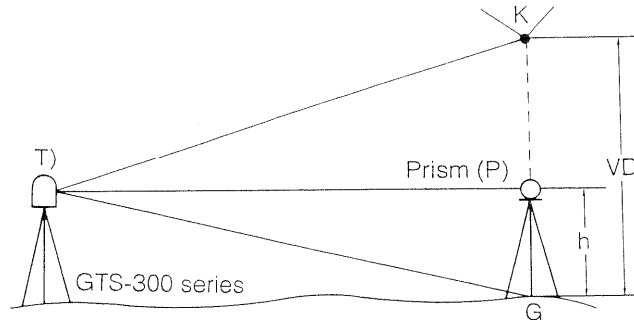

With prism height (h) (Example h=1.5m) input

Operating Procedure	Key Operation	Display
<p>① Set the remote elevation measurement mode.</p>	<p>F/ESC</p> <p>REM MLM</p>	
<p>② Select the mode of with prism height input (1. Input p.h.).</p> <p>The previous input value is shown and its sign blinks.</p>	<p>ENT ANG%</p>	
<p>③ Enter the prism height.</p> <p> key: Set "+" sign.</p> <p> key: Set "-" sign.</p> <p>MEAS key: Blinking digit moves to the right.</p> <p>HOLD key: Blinking digit moves to the left.</p> <p> key: The numerical value of the blinking digit increases.</p> <p> key: The numerical value of the blinking digit decreases.</p>		

[Example]

Enter prism height 1.5m in the status of no previous input value.

- 1) Blink the position of the units
- 2) Set 1 to the position of the units.
- 3) Blink the place of tenth.
- 4) Set 5 to the place of tenth.

④ Press the  key.

⑤ Sight the center of the prism and press the  key.
The horizontal distance from the instrument to the prism will be measured.

⑥ Press the  key.

The prism position will be decided.

⑦ Collimate point K.
Vertical distance (VD) is shown.



Press 3 times.



Press once.





Press once.

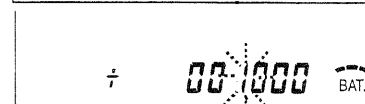
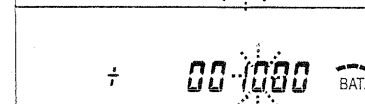
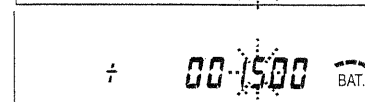
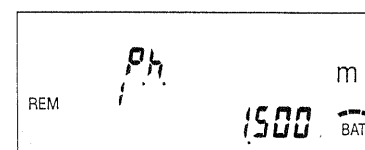
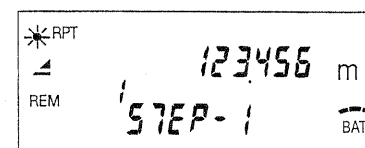
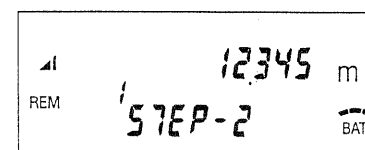

Press 5 times.

- To return to procedure ③, press the  key.
- To return to the previous mode, press the  key.

Without prism height input

Operating Procedure	Key Operation	Display
<p>① Set the remote elevation measurement mode.</p> <p>② Select the mode of without prism height input (2.no p.h.).</p> <p>③ Sight the center of the prism and press the MEAS key. The horizontal distance from the instrument to the prism will be measured.</p> <p>④ Press the ENT ANG% key. The prism position will be decided and the angle measurement mode will be shown.</p> <p>⑤ Collimate point G.</p> <p>Press the ENT ANG% key. The position of point G will be decided.</p> <p>⑥ Collimate point K. Vertical distance (VD) is shown.</p>	<p>F/ESC</p> <p>REM MLM</p> <p>Y - </p> <p>ENT ANG%</p> <p>MEAS</p> <p>ENT ANG%</p> <p>ENT ANG%</p>	   
<ul style="list-style-type: none"> • To return to procedure ③, press the MEAS key. • To return to the previous mode, press the F/ESC key. 		

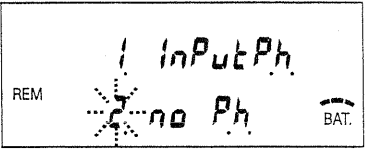
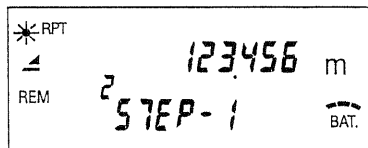
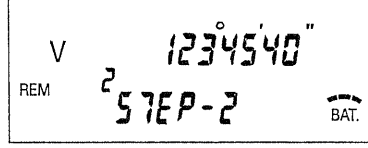
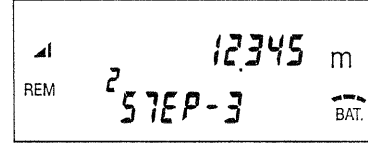
7.2 Missing Line Measurement (MLM)

Measurement for horizontal distance (dHD), slope distance (dSD) and relative elevation (dVD) between two target prisms.

MLM mode has two modes.

MLM-1: measures AB, AC, AD....

MLM-2: measures AB, BC, CD....

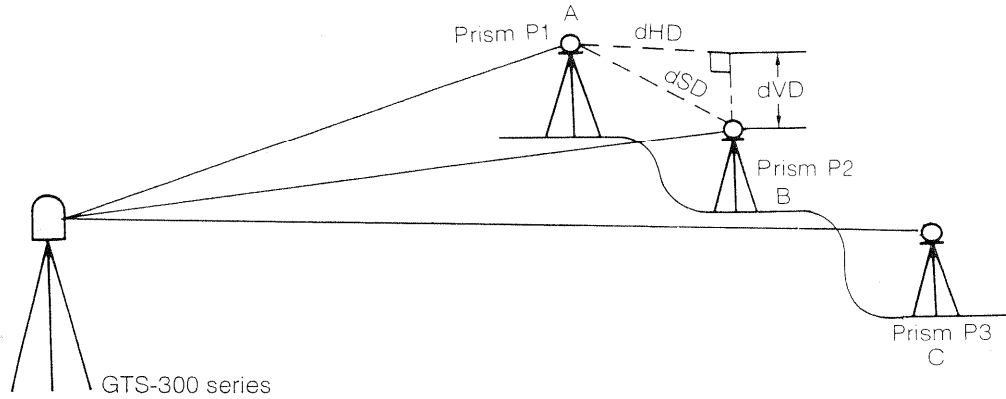

< Example > MLM-1 mode

Operating Procedure	Key Operation	Display
① Set to the MLM mode.	<div style="border: 1px solid black; border-radius: 5px; padding: 2px; display: inline-block;">REM MLM</div>	<div style="border: 1px solid black; padding: 5px;"> </div>
② Select the MLM-1 mode.	<div style="border: 1px solid black; border-radius: 5px; padding: 2px; display: inline-block;">ENT ANG%</div>	<div style="border: 1px solid black; padding: 5px;"> </div>
③ Collimate point A (prism P1) and start distance measuring.	<div style="border: 1px solid black; border-radius: 5px; padding: 2px; display: inline-block;">MEAS</div>	<div style="border: 1px solid black; padding: 5px;"> </div>
Horizontal distance is shown.		<div style="border: 1px solid black; padding: 5px;"> </div>

④ Decide horizontal distance.

ENT
ANG%

⑤ Sight point B (prism P2) and start distance measuring.

MEAS

Horizontal distance is shown.

⑥ Decide horizontal distance.
The horizontal distance (dHD) between points A and B is shown.
To show relative elevation (dVD) and slope distance (dSD), press the  key.

ENT
ANG%

⑦ To measure the distance between points A and C, sight point C (prism P3) and press the  key.
Distance measurement will be started and be shown.

MEAS

⑧ Decide horizontal distance.
The horizontal distance (dHD) between points A and C is shown.

ENT
ANG%

MLM 'STEP-2 BAT.

*RPT
MLM 'STEP-2 BAT.
m

*RPT
MLM 'STEP-2 BAT.
m
246.912

MLM 'A-b A-C BAT.
m
123456

*RPT
MLM 'STEP-2 BAT.
m
358023

MLM 'A-b A-C BAT.
m
234567

- To return to the previous mode, press the  key.

Procedure of MLM-2 mode is completely same as MLM-1 mode.
When selecting MLM-2 mode, press the  key in procedure ①.

7.3 Offset Measurement Mode (Measuring by entering instrument height/prism height)

This mode is useful when it is difficult to set up the prism directly, for example at the center of the tree. Place the prism at the same horizontal distance from the instrument at that of point A_0 to measure.

To measure the coordinates of the center position, operate the offset measurement after setting the instrument height/prism height.

When measuring coordinates of

ground point A_1 of point A_0

: Set the instrument height/prism height.

When measuring coordinates of point A_0

: Set the instrument height only.

Set the prism height to 0 (zero).

- Set the instrument height/prism height before proceeding to the offset measurement mode.
- When measuring by setting the coordinate values of occupied point and entering instrument height/prism height, refer to "6.COORDINATES MEASUREMENT".

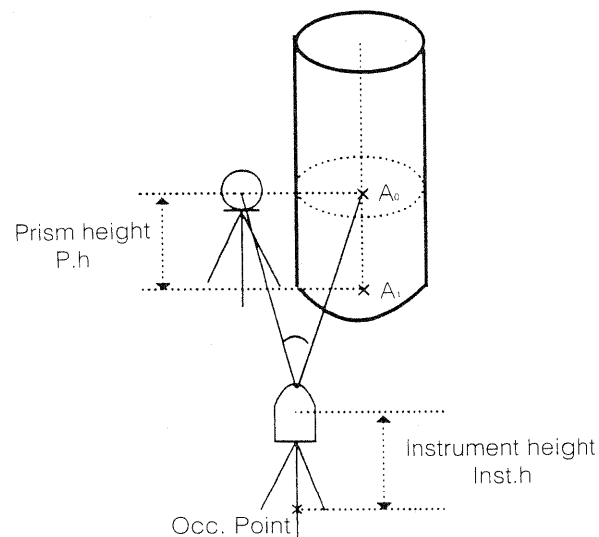

- When measuring by setting the coordinate value for the occupied point, refer to "6.2 Setting Coordinate values of Occupied Point (OCC. POINT)".

Operating Procedure	Key Operation	Display
① Set the offset measurement mode.	<p>F/ESC</p> <p>OFFSET REP</p>	
② Sight the prism and press the MEAS key.	<p>MEAS</p>	

The horizontal distance from the instrument to the prism will be measured.

③ Decide the prism position.

④ Use the horizontal motion clamp and horizontal tangent screw to collimate point A₀.

⑤ Show the relative elevation of point A₀.

⑥ Show the slope distance of point A₀.



- Each time pressing the  key, horizontal distance, relative elevation and slope distance are shown in sequence.

⑦ Show N(X) coordinate of point A₀ or A₁.

- Each time pressing the  key, N(X), E(Y) and Z coordinates are shown in sequence.

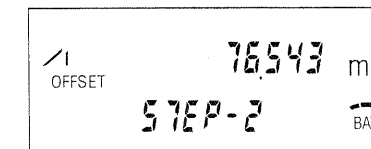
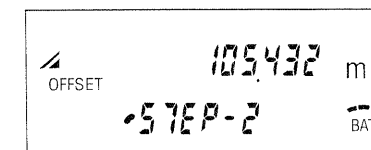
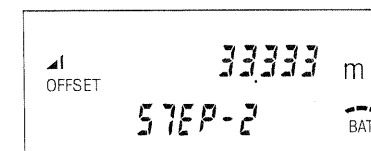
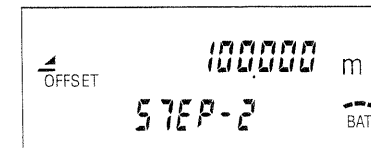
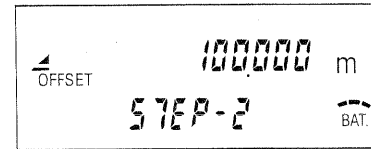
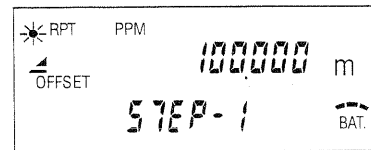
ENT
ANG%



- To return to procedure ②, press the  MEAS key.
- To return to the previous mode, press the  F/ESC key.

8. OTHER FUNCTIONS

8.1 Set Audio Mode

In this mode, atmospheric correction value (PPM), prism constant (PSM) and return signal level (SIG) are shown.

A buzzer sound will be generated when the instrument receives the return signal from the prism, which is useful if you have trouble to sight the prism.

- Operating procedure

Press the  key.

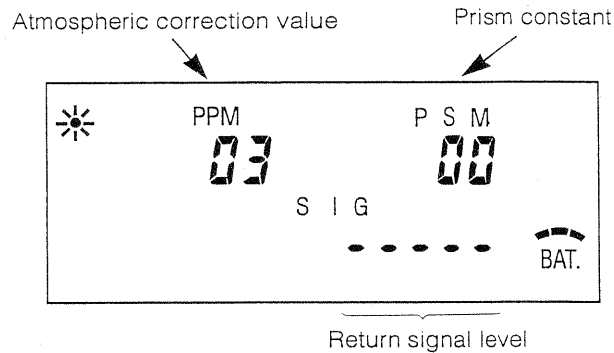

- A buzzer sound will be generated when the instrument receives the return signal from the prism.
- In proportion as the return signal decreases, the light for the mark "●" will go off one by one from the right.
- If the return signal is reflected to other direction, not to the instrument, the buzzer sound will stop and the mark "☀" will blink.
- To stop a buzzer sound, refer to "14.SELECTING MODE".
- If you press the  key again at the set audio mode, the input mode for atmospheric correction value and prism constant is set. Refer to "12. ATMOSPHERIC CORRECTION AND PRISM CONSTANT".

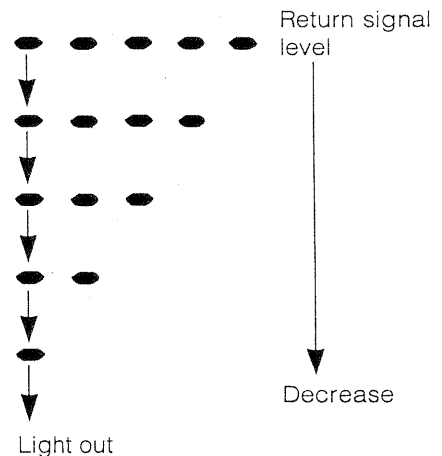



8.2 Auto Power Off (APF ON/OFF)

If no key operation is given or no process of measurement is performed for more than 30 minutes (No change exceeding 30" has occurred during angle measurement.), the power turns off automatically.

Or no change in distance exceeding 10cm has occurred during distance measurement, the mode changes to angle measurement automatically in case that the instrument does not operate for approximately 10 minutes, and the power turns off more than approximately 20 minutes after that.

- It is possible to stop the auto power off function. See "14. SELECTING MODE".

8.3 Lighting for the Reticule and the Indicator

The lights for the reticule and the indicator are lit up by pressing the  key, and they go off by pressing the  key again.

9. POWER SOURCE AND CHARGING

9.1 Handle Battery (Internal) BT-24Q

- Installation

- 1) Place the mounting fixture of the BT-24Q into the plate opening on top of the standard as shown below.
- 2) While pushing the battery locking lever, gently push the handle battery toward the lock lever side till the handle battery comes to the end of the instrument and clicks into position.
- 3) Tighten the battery locking screw.

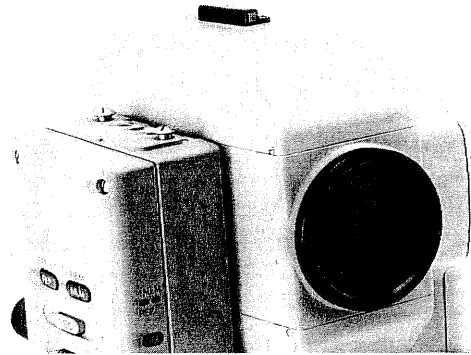
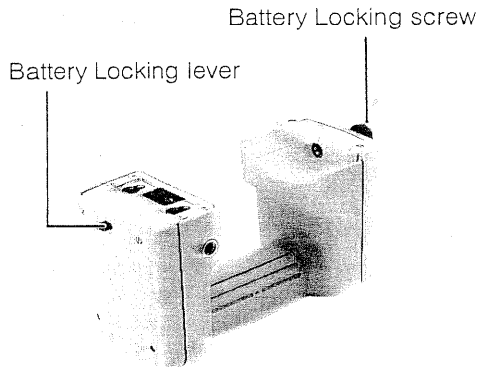

- For removing

- ① Loosen the battery locking screw.
- ② Push the lock lever toward the locking screw side till the handle battery slide.

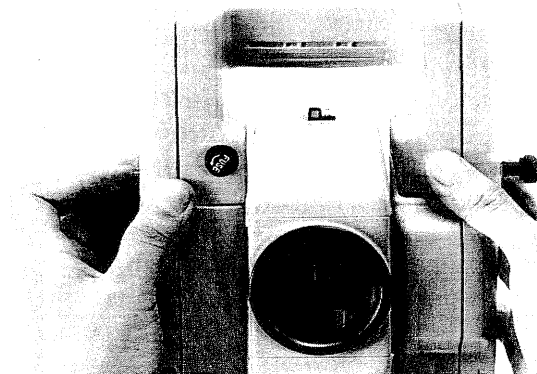

- For charging

- ① Connect charger connector (BC-20B or BC-20C) to the handle battery at connector (A), the handle battery should be removed from the instrument when recharging.
- ② Plug the charger into an outlet (BC-20B is for AC120V use and BC-20C is for AC230V use).
- ③ The red light of the charger will light.
- ④ Charging will take approximately 1.5 hours (Green lamp of the charger lights.).
Remove the battery source from the charger.

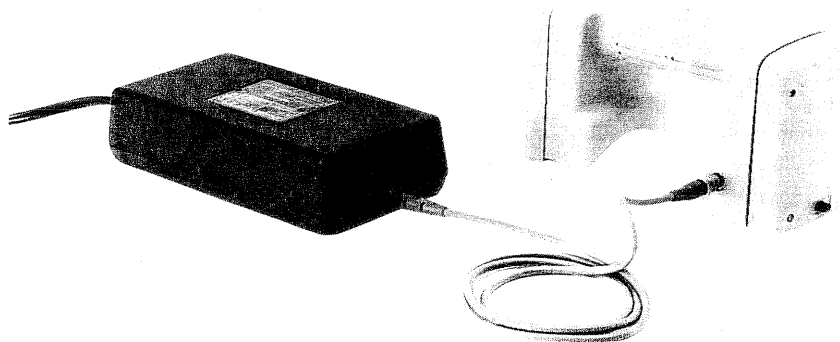

Notes

- Recharging should take place in a room with an ambient temperature range of 10°C to 40°C (50°F to 104°F).
- Exceeding the specified charging time may shorten the life of the battery and should be avoided if possible.
- The battery source will discharge when stored and should be charged before using with instrument.
- Be sure to charge the battery source every 3 or 4 months and store in a place at 30°C and below if it will not be used for a long time.
- **For further information, see page 68.**

9.2 Charging the External Power Sources BT-3Q and BT-3L

- ① Connect the charger and the connector of external power source.
- ② Insert the charger into the outlet.
- ③ Turn the power switch of external power source ON.
- ④ Make sure that the red light of the charger lights.
- ⑤ Turn OFF the power switch and remove the external power source from the charger after charging.

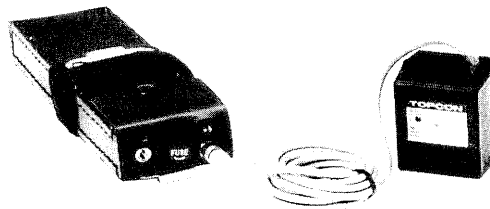

- Relating to combination of the external power source and the charger and also its charging hours, see "18. BATTERY SYSTEM".

10. DETACHABLE TRIBRACH

- For detaching
 - 1) Loosen locking lever on the tribrach.
 - 2) Lift the instrument up and remove.
- For attaching
 - 1) Match the instrument base with the correct groove before putting the instrument on the board.
 - 2) Tighten the locking lever.

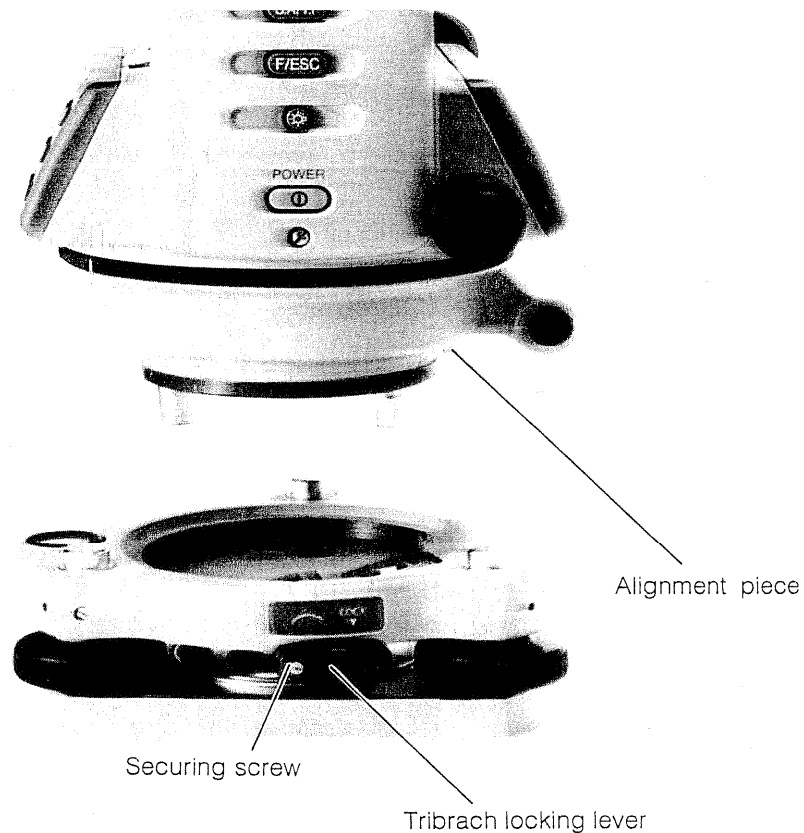

- **Locking Lever and Securing Screw for Use**
Turn the securing screw by using a screwdriver and secure the locking lever when it is unnecessary to remove the instrument. This will help to prevent accidents including an accidental fall. Make sure the screw is tightened firmly.

11. PRECAUTIONS

- For transportation, hold by the handle or yoke of the instrument. Never hold by the lens barrel as it can affect the fixing bracket inside and reduce the accuracy of the instrument.
- Never expose the instrument without a filter to direct sunlight. It may damage the components inside the instrument.
- Never leave the instrument unprotected in high temperature. The temperature inside instrument may easily reach up to 70°C or above and will reduce the service life.
- When a high degree of precision is required for measurement, provide shade against direct sunlight for the instrument and tripod.
- Any sudden change of temperature to the instrument or prism may result in a reduction of measuring distance range, i.e. when taking the instrument out from a heated vehicle.
- When opening the carrying case and taking out the instrument, place the case horizontally, then open the case.
- When returning the instrument to its case, be sure to match the white positioning marks provided with the case and place the instrument with the eyepiece upward.
- For transportation, provide dampening or a cushion appropriately to avoid sudden shock or vibration.
- For cleaning the instrument after use, remove dust using a cleaning brush, then wipe off with a cloth.
- For cleaning the lens surface, use a cleaning brush to remove the dust, then use a clean lintless cotton cloth. Moisten it with alcohol (or mixture with ether) to wipe gently in a rotational motion from the center out.
- Even if any abnormality occurs, never attempt to disassemble or lubricate the instrument yourself. Always consult with TOPCON or your dealer.
- To remove the dust on the case, never use thinner or benzine. Use a clean cloth moistened with neutral detergent.

12. ATMOSPHERIC CORRECTION AND PRISM CONSTANT

12.1 Atmospheric Correction

The velocity of light through air is not constant but depends on the atmospheric temperature and pressure, which makes it necessary to correct for the ambient atmospheric temperature and pressure in order to obtain distance measurements of high accuracy.

An atmospheric correction system is built into the instrument and, therefore, the displayed distance measurements are automatically corrected when the required correction is stored into the memory of the instrument from the keyboard.

In the instrument, the temperature and the atmospheric pressure are automatically corrected by entering them directly from the keyboard.

Atmospheric Correction Chart (Reference)

The atmospheric correction value is obtained with the atmospheric correction chart, in the following manner:

- 1) Measure the ambient temperature and pressure at both instrument position and prism reflector position. Average the results.

CAUTION: The thermometer and barometer should not be exposed directly to the sunlight.

- 2) Locate the measured temperature on the horizontal scale of the atmospheric correction chart.
- 3) Locate the measured pressure on the vertical scale of the atmospheric correction chart.
- 4) Find the intersection of the measured temperature and pressure on the chart and read the PPM (parts per million) value from the diagonal line, which will be the required atmospheric correction.

Example

The measured temperature is.....+26°C

The measured pressure is.....760mmHg

Therefore,

The correction value is.....+10ppm

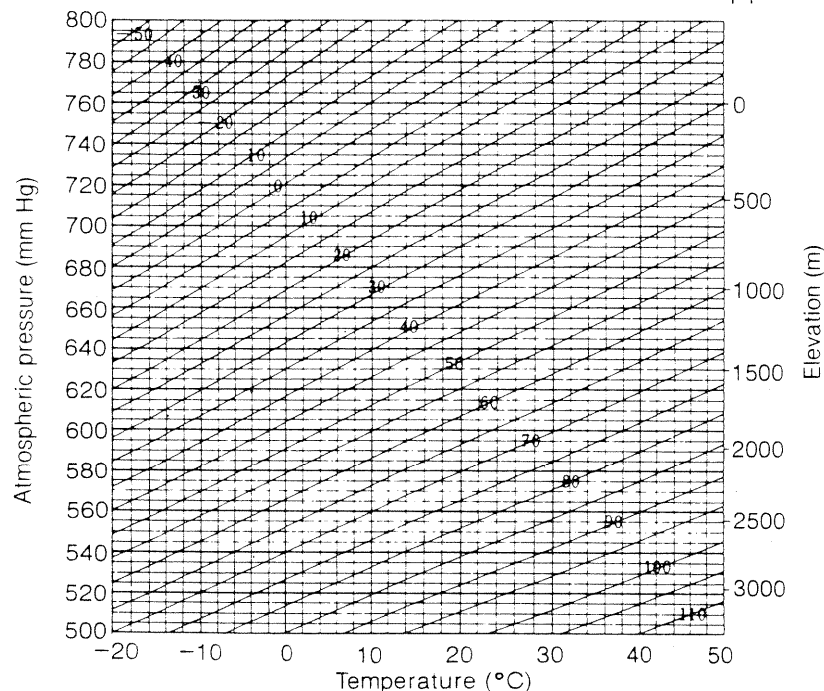

Atmospheric correction chart

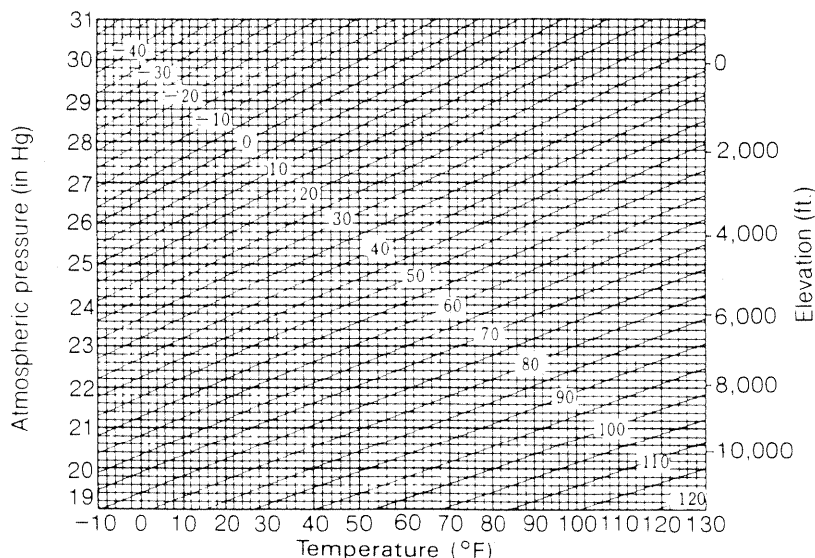

Atmospheric correction chart

· Refer to page 74 for the atmospheric correction chart (hPa unit).

12.2 Atmospheric Correction Calculation

The atmospheric correction K_a and the distance after correction L can also be obtained in the following manner. First, the atmospheric correction value K_a is obtained from the following formula:

$$K_a = \left(279.66 - \frac{106.036 \times P}{273.16 + t} \right) \times 10^{-6}$$

when,

P : Ambient atmospheric pressure (mm Hg)

t : Ambient atmospheric temperature ($^{\circ}\text{C}$)

Then the distance after correction L is obtained from the following formula:

$$L = l(1 + K_a) \text{ (m)},$$

l = Distance measured with the instrument, when $K_a = 0$ (ppm).

Example

when the atmospheric temperature is 20°C , the atmospheric pressure 635mmHg and the measured distance 1,000.000m, the atmospheric correction value K_a and the distance after correction L are obtained with the following calculations:

$$\begin{aligned} K_a &= \left(279.66 - \frac{106.036 \times 635}{273.16 + 20} \right) \times 10^{-6} \\ &= 50 \times 10^{-6} \\ &= 50 \text{ (ppm)} \end{aligned}$$

$$\begin{aligned} L &= 1,000.000 \times (1 + 50 \times 10^{-6}) \\ &= 1,000.050 \text{ (m)} \end{aligned}$$









12.3 Prism Constant

The prism constant for TOPCON prisms is 0. If the prism of other manufacturers than TOPCON is used, the appropriate constant shall be set beforehand.

The constant is kept in the memory even after power is shut off.

12.4 How to Set the Atmospheric Correction (Temperature & Atmospheric Pressure) and Prism Constant

Entering directly temperature and atmospheric pressure

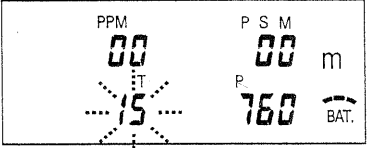
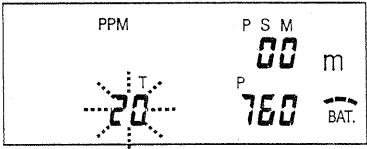
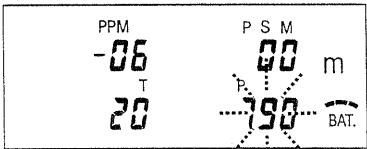
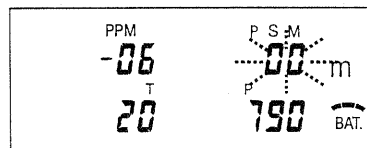











Operating Procedure	Key Operation	Display
<p>① Set the instrument to the mode for setting atmospheric correction values and the prism constant.</p> <p>② Enter the temperature.</p> <p> key: increases the numerical value.</p> <p> key: decreases the numerical value.</p> <p>③ Enter the atmospheric pressure.</p> <ul style="list-style-type: none"> After pressing the  key and then the  key, you do not have to enter the prism constant. <p>④ Enter the prism constant.</p> <p>The operation will return to the set audio mode.</p>	<p> </p> <p>Set temperature.</p> <p></p> <p>Set atmospheric pressure.</p> <p></p> <p>Set prism constant.</p> <p></p>	   

Input range

	m Display	ft display
Temperature	-30 to +60°C (in 1°C increment)	-22 to +140°F (in 1°F increment)
Atmospheric Pressure	420 to 800mmHg (1mmHg)	16.5 to 31.5inHg (0.1inHg)
	0560 to 1066hPa (1hPa)	
Prism Constant	±99mm (in 1mm steps)	

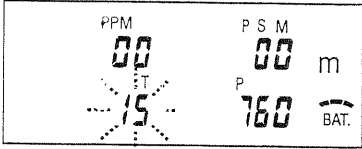
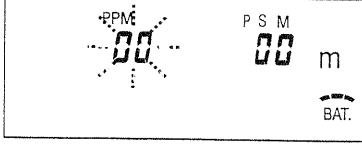
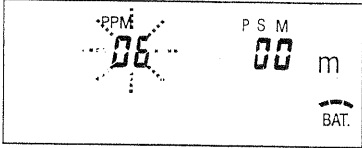
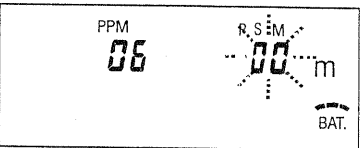
- If the atmospheric correction is more than ±99ppm, the display will return to procedure ②.

Entering directly atmospheric correction value

Operating Procedure	Key Operation	Display
<p>① Set to the mode for setting atmospheric correction values and the prism constant. Temperature blinks.</p> <p>② Set to the direct input mode for atmospheric correction value. Atmospheric correction value blinks.</p> <p>③ Enter atmospheric correction value.</p> <p> key: The numerical value of the blinking digit increases.</p> <p> key: The numerical value of the blinking digit decreases.</p> <ul style="list-style-type: none"> After pressing the  key and then the  key, you do not have to enter the prism constant. <p>④ Enter prism constant.</p> <p>The operation will return to the set audio mode.</p>	<p> </p> <p></p> <p>Set atmospheric correction value.</p> <p></p> <p>Set prism constant.</p> <p></p>	   
<ul style="list-style-type: none"> The number of the digit increases by pressing the  key and decreases by pressing the  key. When you set the atmospheric correction value or the prism constant, "00" can be set quickly by pressing the  key. 		

13. CORRECTION FOR REFRACTION AND EARTH CURVATURE

The instrument measures distance, taking into account correction for refraction and earth curvature.

Note: If the telescope is positioned within $\pm 9^\circ$ from the nadir or zenith, no measurement will result even if the correction function for refraction and earth curvature works.

13.1 Distance Calculation Formula

Distance Calculation formula; with correction for refraction and earth curvature taken into account. Follow the formula below for the converting horizontal and vertical distances.

Horizontal distance $D = AC(\alpha)$ or $BE(\beta)$

Vertical distance $Z = BC(\alpha)$ or $EA(\beta)$

$D = L[\cos\alpha - (2\theta - \gamma)\sin\alpha]$

$Z = L[\sin\alpha + (\theta - \gamma)\cos\alpha]$

$\theta = L \cdot \cos\alpha / 2R$ Earth curvature correcting item

$\gamma = K \cdot L \cdot \cos\alpha / 2R$ Atmospheric refraction correcting item

$K = 0.14$ (or 0.2)..... Coefficient of refraction

$R = 6372 \text{ Km}$ Radius of earth

α (or β)..... Altitude angle

L Slope distance

- The conversion formula for horizontal and vertical distances is as follows when correction for refraction and earth curvature is not applied.

$$D = L \cdot \cos\alpha$$

$$Z = L \cdot \sin\alpha$$

- If you want to stop correction for refraction and earth curvature and change the value "K" of coefficient of refraction, see "14. SELECTING MODE".

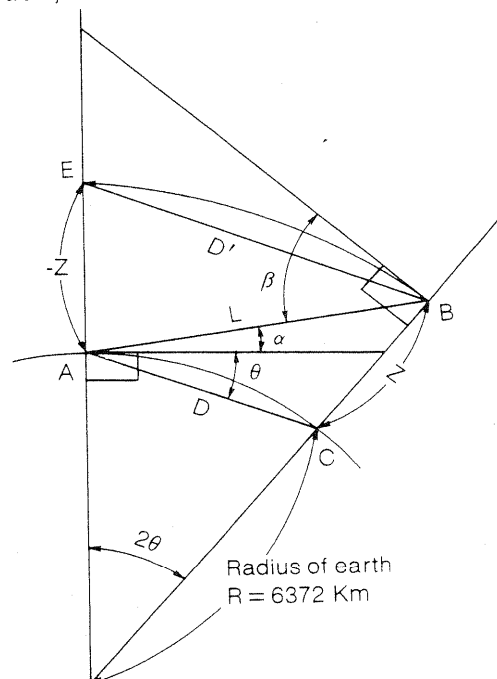







Note: The coefficient of the instrument has been set at 0.14 before shipment ($K=0.14$). If the value "K" is to be changed, see "14. SELECTING MODE".

14 SELECTING MODE

14.1 Items of the Selecting Mode

Selecting Mode 1				
Digit No.	Selecting Items	Selecting Contents	Setting Value=0	Setting Value=1
1	Angle units: DEG/GON	Select DEG or GON unit for measuring angle.	DEG	GON
2	Angle units: DEG/GON/MIL	Select DEG, GON or MIL unit for measuring angle.	DEG/GON	MIL
3	Vertical angle: zenith 0/level/0	Select the vertical angle reading from zenith or from level.	Zenith 0	Level-0
4	Detecting horizontal angle at 0°00'00"	Select to set at 0°00'00" by the horizontal angle 0 detection.	No	Yes
5	Memorizing horizontal angle	When you detect horizontal angle at 0°00'00", select to memorize or not memorize the 0-set position.	No	Yes
6	Switching minimum reading units.	Select for the minimum reading unit on the display.	5"(GTS-301) 5"(GTS-302) 10"(GTS-303)	1"(GTS-301) 1"(GTS-302) 5"(GTS-303)
7	Tilt correction	Select to correct or not correct the tilt.	No	Yes
8	Auto power off	Select to use or not use the auto power off function.	No	Yes

Selecting Mode 2				
Digit No.	Selecting Items	Selecting Contents	Setting Value=0	Setting Value=1
1	Distance units: meter / feet	Select meter or feet unit for measuring distance.	meter	feet
2	Distance in display order	Select to display horizontal distance or slope distance first for measuring distance	   (HD→RE→SD)	   (SD→HD→RE)
3	TRK/CRS	Select the measurement mode for tracking or coarse for measuring distance.	TRK	CRS
4	Minimum reading units: TRK/CRS	Select 1cm or 1mm unit for the minimum reading in the measurement mode of tracking or coarse.	1cm	1mm
5	Correction for refraction and earth curvature	Select to correct or not correct refraction and earth curvature.	No	Yes
6	Correction value for refraction and earth curvature	Select to set 0.14 or 0.20 for the earth curvature coefficient (k) when you correct refraction and earth curvature.	K=0.14	K=0.20
7	Memorizing coordinate value	Select to memorize or not memorize the instrument coordinate value that has been set after the power is turned off.	No	Yes
8	Minimum reading units for distance Note 1)	Select 1mm or 0.2mm for the minimum reading unit in the distance mode (FINE mode) on the display.	1mm (0.005ft)	0.2mm (0.001ft)

Selecting Mode 3				
Digit No.	Selecting Items	Selecting Contents	Setting Value=0	Setting Value=1
1	Data type for output	Select REC-A or REC-B data type for output REC-A: Outputs the re-measured data. REC-B: Outputs the data currently displayed	REC-A	REC-B
2	CR, FL	Select to output or not output data with carriage return and line feed.	No	Yes
3	Echo back	Select to output or not output data of echo back type.	No	Yes
4	Buzzer sound at the set audio mode	Select to on or off the buzzer sound at the set audio mode	OFF	ON
5	Measurement mode when powering up	Select to set the measurement mode for angle or distance when the power is turned on.	Angle measurement	Distance measurement
6	Outputting data (Note2),3)	Select 1mm or 0.2mm for the data output mode.	1mm mode output	0.2mm mode output
7	Coordinates in display order and input order	Select X·Y·Z or Y·X·Z for the display order of coordinate measurement and the input order of coordinate values.	X·Y·Z	Y·X·Z
8	FINE/CRS (N-time meas.mode)	Select FINE or COARSE mode in the N-time measurement mode.	FINE	CRS

Selection Mode 4				
Digit No.	Selecting Items	Selecting Contents	Setting Value=0	Setting Value=1
1	Atmospheric pressure unit	Selecting YES/NO to input in hPa unit.	No	Yes
2	Tilt sensor mode	Selecting Dual / Vertical tilt sensor mode (GTS-301D/302D/303D only)	Dual	Vertical
3	Conversion factor M/F	Select conversion factor	U.S. Sur. foot	Intl. foot

Note 1) Switching the minimum reading units for distance

You can select 1mm (0.005ft) mode or 0.2mm (0.001 ft) mode for the minimum reading units for distance.

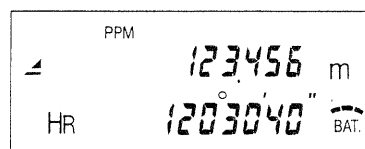

1mm mode

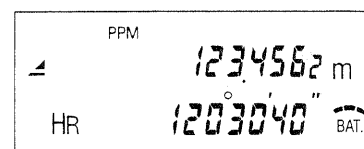

0.2mm mode

- When setting coordinate values for occupied point, standard distance for stake out and instrument height/prism height, you can enter the data according to the minimum reading unit that you set here.
- If the minimum distance is set for the 0.2mm mode distances measured must be less than 1000m (3280.84ft).









Note 2)

Topcon data collector FC-5 is designed for the angle/distance mode of 0.2mm mode output data.







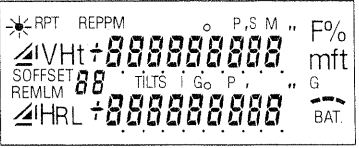
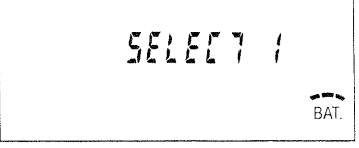
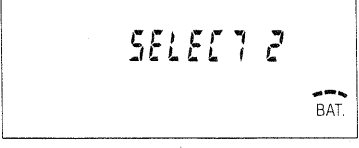
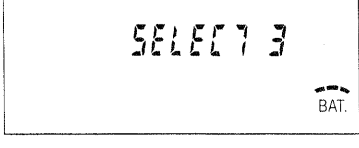
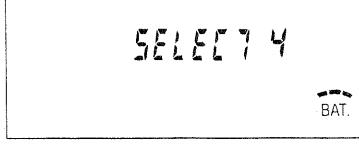
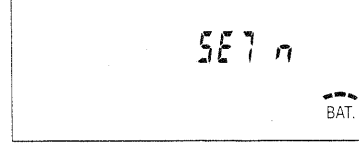



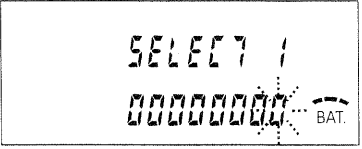

Note 3)

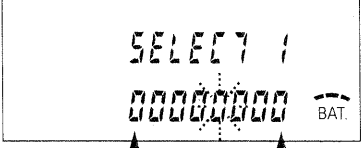
When using the 0.2mm mode output by connecting GTS-300 and a computer, refer to the GTS-300 interface manual (Ver. 1.20~) which is optionally available.



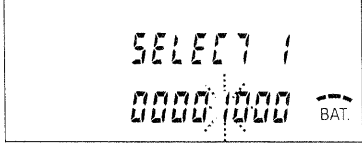

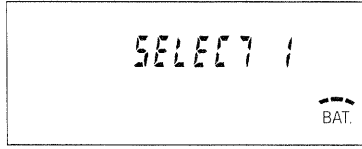

14.2 How to set the Selecting Mode**14.2.1 Selecting the setting mode for selecting or N-time distance measurement**

Operating Procedure	Key Operation	Display
<p>① Turn the power ON while pressing the  key.</p> <p>After Showing all segments for approx.2 seconds, title of the selecting mode 1 will be shown.</p> <p>② Select the setting mode.</p> <p>Select the setting mode by pressing the  key or the  key.</p> <p>③ Set the required selecting mode by pressing the  key.</p>	<p> + </p> <p> OR </p> <p></p>	 <p>All segments</p>  <p>Selecting mode 1</p>  <p>Selecting mode 2</p>  <p>Selecting mode 3</p>  <p>Selecting mode 4</p>  <p>N-time distance measurement mode</p>

14.2.2 How to set the selecting mode

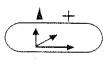
Operating Procedure	Key Operation	Display
<p>① Select the selecting mode. Operate "14.2.1 Selection the Setting Mode for Selecting". The data previously set is shown with the most right digit (digit No.1) blinking.</p>		
<p>② Let the digit No. to be set blink.</p> <p> key: Blinking digit moves to the left.</p> <p> key: Blinking digit moves to the right.</p>	<p> or </p>	 <p style="text-align: center;">Digit No. 8 Digit No. 1</p>
<p>③ Set a value for the digit blinking.</p> <p> key: Set "1" for the digit.</p> <p> key: Set "0" for the digit.</p>	<p> or </p>	
<p>④ Set the required value by repeating procedures ② and ③.</p>		
<p>⑤ Complete the setting procedure.</p>	<p></p>	
<p>⑥ Turn the power OFF.</p>	<p></p>	

14.2.3 How to set N-time distance measurement

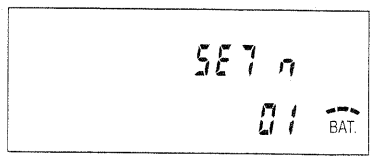
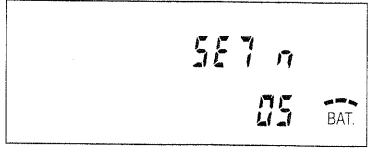
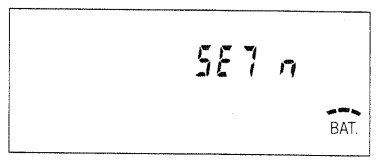
Operating Procedure	Key Operation	Display
<p>① Select the setting mode for N-time distance measurement. Operate "14.2.1 Selecting the Setting Mode for N-time distance measurement". The numerical value of times previously set is shown with blinking.</p> <p>② Set the number of times for measuring.</p> <p> key: The numerical value of blinking digit increases.</p> <p> key: The numerical value of blinking digit decreases.</p> <p>③ Complete the setting procedure.</p> <p>④ Turn the power OFF.</p>	<p> or </p> <p></p> <p></p>	<p></p> <p></p> <p></p>
<ul style="list-style-type: none"> You can set the numerical value of times for measuring 1 to 99. 		

15. CHECK AND ADJUSTMENT

15.1 Checking and Adjusting the Instrument Constant

Normally, the instrument constant does not have discrepancy. However, it is recommended to measure comparing with an accurately measured distance at the place where the precision is specifically indicated once every six months. If you cannot find a neighboring place with the precision specifically indicated, provide a baseline over 20m (when purchasing the instrument) and compare with the data measured when purchasing the instrument.

In such case, note that the setup displacement of the instrument and the prism, base-line precision, poor collimation, atmospheric correction and correction for refraction and earth curvature determine the inspection precision. Thus, please keep in mind these points.

Also, when providing a base-line in a building, please note that the difference in temperature greatly changes the length of the building. If the difference is 5mm or over resulting from the comparative measurement, follow the procedure as shown below to change the instrument constant.

① Provide point C on a straight line, connecting straight line \overline{AB} which is almost horizontal and about 100m long, and measure straight lines \overline{AB} , \overline{AC} and \overline{BC}

② Obtain the instrument constant by repeating ① above several times.

$$\text{Instrument constant} = \overline{AC} + \overline{BC} - \overline{AB}$$

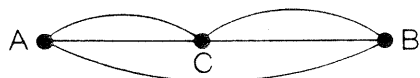

③ Confirm the instrument constant of your instrument by referring to "15.5 How to set the Instrument Constant".

If you find the difference between the instrument constant and your newly checked instrument constant, set again by referring to "15.5 How to Set the Instrument Constant".

④ Once again, measure at the place where the precision is specifically indicated and compare with its base-line length.

⑤ If in ③ above no difference is found from the instrument constant at the factory or in ④ above the difference over 5mm is found, contact TOPCON or your TOPCON dealer.

15.2 Checking the Optical Axes of EDM and Theodolite

To check if the optical axes of EDM and theodolite are matched, follow the procedure below.

If you adjusted the cross hairs (15.3.3 and 15.3.4), the optical axes must be checked.

- ① Position the instrument and prism about 2m between them, and face them straight each other. (At that time, the power is ON.)

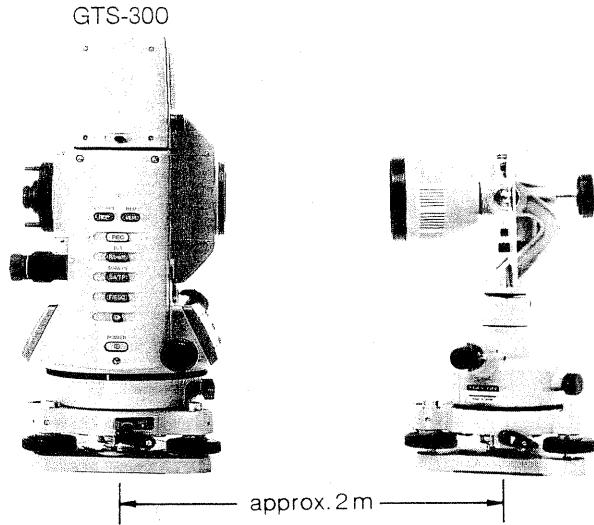

- ② Look through the eyepiece and focus on the center of the prism.

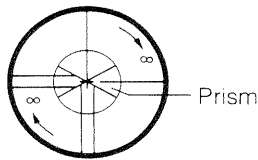

- ③ Set to the mode of continuous measurement for distance or set audio.
- ④ Look through the eyepiece. If displacement of the reticle cross hairs is within one-fifth of the diameter of the red light spot adjustment will not be required. If displacement is more than one-fifth, contact TOPCON or your TOPCON dealer to adjust the instrument.

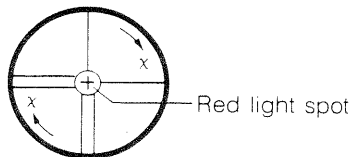

15.3 Checking and Adjusting Theodolite Function

• Notes on the Adjustment

- ① Carry out the adjustments in the order of item numbers, as the adjustments are dependent one upon another. Adjustments carried out in the wrong sequence may even nullify previous adjustment.
- ② When you adjust one item only, check and adjust the following items in the order of item numbers:
After adjusting "15.3.3", check and adjust "15.3.4" and "15.3.6".
After adjusting "15.3.4", check and adjust "15.3.6".
- ③ Always conclude adjustments by tightening the adjustment screws securely (but do not tighten them more than necessary, as you may strip the threads, twist off the screw or place undue stress on the parts). Furthermore, always tighten by revolving in the direction of tightening tension.
- ④ Each attachment screw must also be tightened sufficiently, upon completion of adjustment.
- ⑤ Always repeat checking operations after adjustment in order to confirm if the adjustment has been made properly.

• Other Adjustment

- ① If any leveling screw becomes loose and slack or if collimation is unstable due to the looseness of leveling screws, adjust by tightening the adjustment screws (in 2 places) installed over each leveling screw with a screwdriver.
- ② If there is any slack between the leveling screws and the base, loosen the setscrew of the holding ring and tighten the holding ring with adjusting pin.

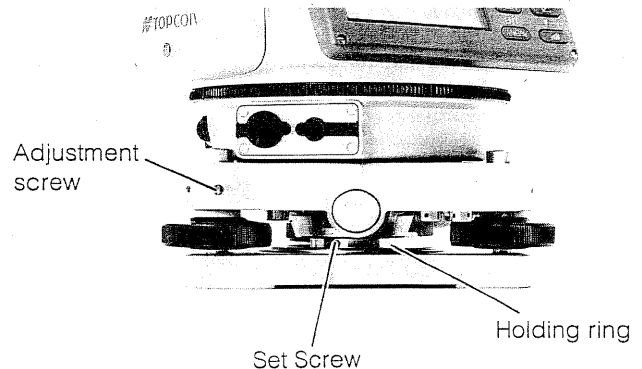

15.3.1 Checking and adjusting the plate level

- Check

- ① Place the plate level vial A parallel to a line running through the centers of two leveling screws, say, A and B. Use these two leveling screws and place the bubble in the center of the plate level vial.
- ② Rotate the instrument 180° or 200gon around the vertical axis and check bubble movement of the plate level. If the bubble is in the center of the plate level vial, adjustment is not required. If the bubble has been displaced, then proceed with the following adjustment.

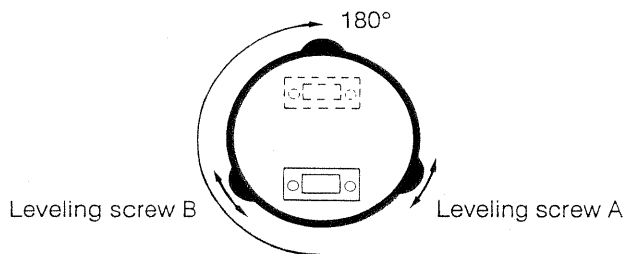

- Adjustment

- ① Turn the adjustment capstan screw with the accessory rod pin and return the bubble towards the center of the plate level only one-half of the displacement.
- ② Place the bubble in the center of the plate level by turning the leveling screws.
- ③ Rotate the instrument 180° or 200gon to return to the original position. If the bubble is in the center of the plate level vial, adjustment completes. If the bubble is still displaced, then repeat the adjustment.

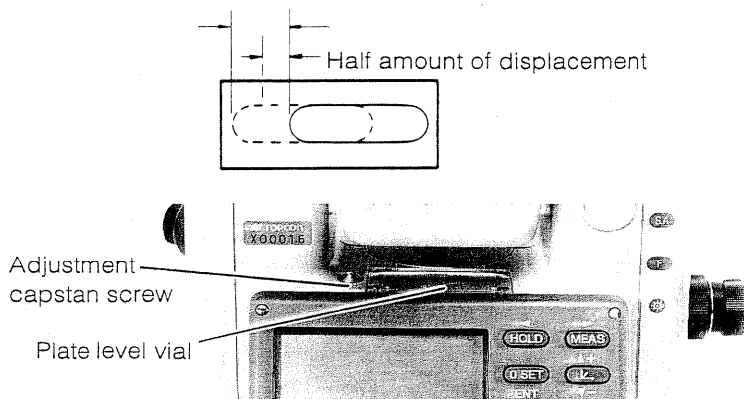

15.3.2 Checking and adjusting the circular level

- Check

Carefully level the instrument with the plate level only. If the bubble of the circular level is centered properly, adjustment is not required. Otherwise, proceed with the following adjustment.

- Adjustment

Shift the bubble to the center of the circular level, by turning three capstan adjustment screws with the accessory adjusting pin.

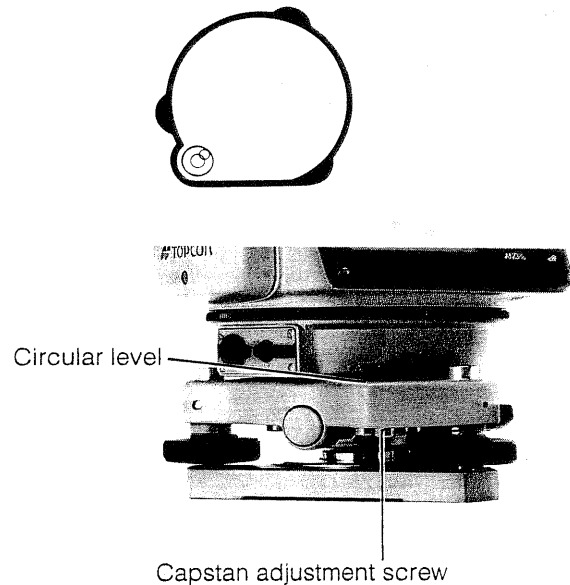

15.3.3 Checking and adjusting the vertical cross-hair line

- Check
- ① Place the target (point A) on the collimation axis (intersection of the cross hairs) and tighten each fixing screw.
- ② Move point A to point A' along the vertical cross hair line by turning the vertical tangent screw. If point A' travels along the length of the vertical cross-hair line, adjustment is not required. If not, proceed with the following adjustment.

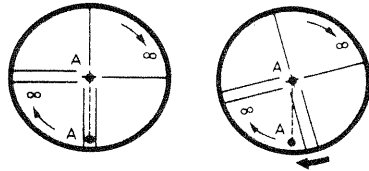

- Adjustment
- ① Unscrew the eyepiece section cover.
- ② Loosen all four attachment screws slightly with the accessory screwdriver and turn the entire eyepiece section with your fingers so that the vertical cross-hair line is coincided to point A'.
- ③ Tighten the four attachment screws again.
- ④ Check once more and if point A is on the intersection of the cross hairs and point A' travels the entire length of the vertical cross-hair line, further adjustment is not required.

Eyepiece section attachment screw

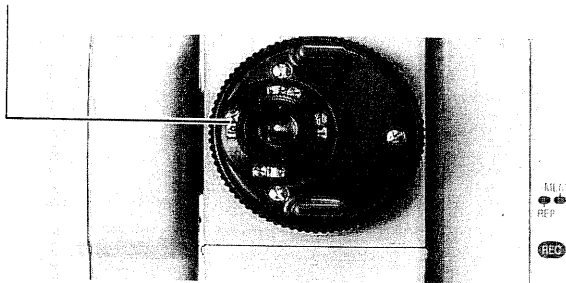

After adjustment, please check and adjust the collimation axis and adjust vertical angle 0 datum (see 15.3.4 and 15.4) without fail.

15.3.4 Checking and adjusting collimation of the instrument

- Check
- ① Level the instrument properly with the plate level.
- ② Sight point A at approximately 50 meter (160 ft.) distance and tighten all fixing screws.

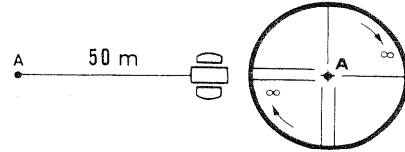

- ③ Loosen the vertical tangent clamp only and rotate the telescope 180° or 200 g around the horizontal axis, so that the telescope is pointed in the opposite direction. Sight point B at equal distance as point A and tighten the vertical motion clamp.

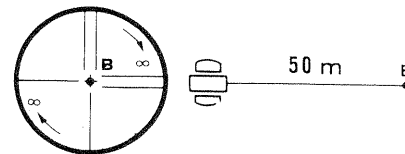

- ④ Loosen the horizontal motion clamp and rotate the instrument 180° or 200gon around the vertical axis. Sight point A once more and tighten the horizontal motion clamp.

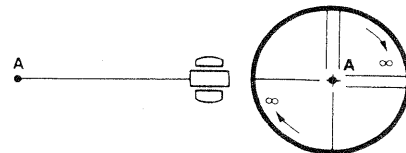

- ⑤ Loosen the vertical motion clamp only. Rotate the telescope 180° or 200gon around the horizontal axis once more and decide point C to sight. If point C coincides with the previous point B, adjustment is not required. Tighten the vertical motion clamp. If points B and C do not coincide, adjust in the following manner.

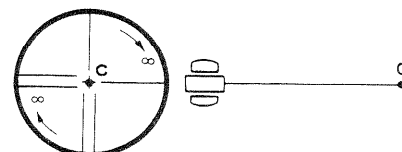

- Adjustment

- ① Unscrew the cross-hair adjustment section cover.
- ② Find point D at a point between points C and B, which should be equal to 1/4th the distance between points B and C and measured from point C.

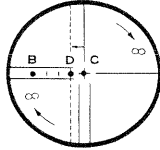

- ③ Shift the vertical cross-hair line and coincide it with point D, by turning the left and right cross-hair adjustment screws with the adjusting pin. Repeat the checking operation once more. If points B and C coincide, further adjustment is not required. Otherwise, repeat the adjustment.

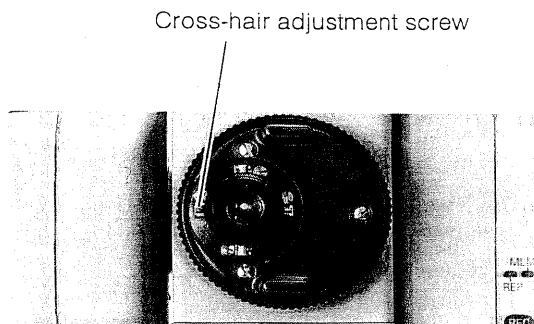

- Since the reticle is fixed with screws from right and left, the cross hairs move by loosening the screw on the side of the moving direction and tightening the opposite side screw. And finally tighten screws on both sides and fix the reticle.
- After the adjustment, please check and adjust optical axes of EDM and theodolite (see 15.2).

15.3.5 Checking and adjusting the optical plummet telescope

- Check

- ① Coincide the center mark of optical plummet telescope with the point.
(See on page 11 "Leveling and centering the instrument (Reference)".)
- ② Rotate the Instrument 180° and observe the point with the optical plummet telescope. If the point is properly centered on the center mark, adjustment is not required. If not, proceed with the following adjustment.

- Adjustment

- ① Shift the center mark toward the point as much as one-half of the displacement with four (4) adjustment screws of optical plummet telescope.

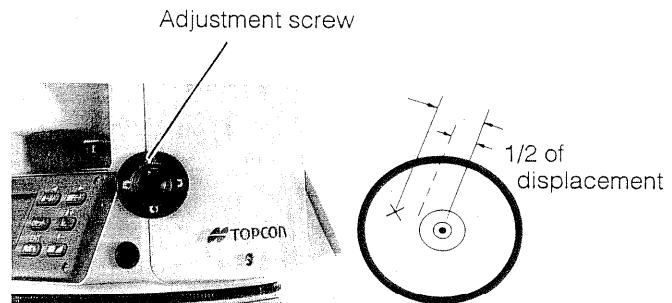







- ② Place the center mark on the point with the leveling screw.
- ③ Further rotate the body 180°. If the point is placed on the center mark, further adjustment is not required. If not, repeat the adjustment.







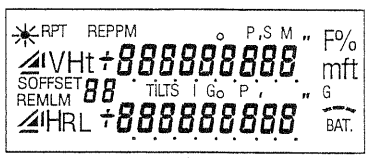
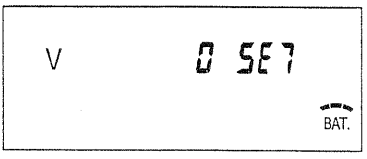
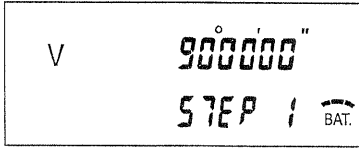
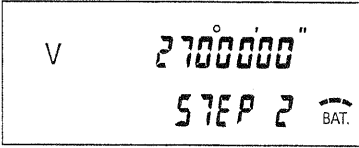
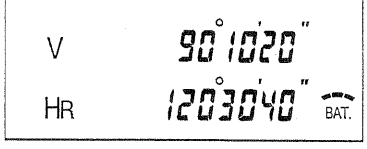

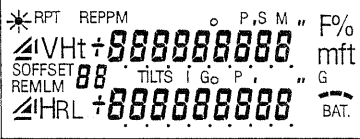

Since the reticle is fixed with screws from up and down and from right and left, the center mark moves by loosening the screw on the side of the moving direction and tightening the opposite side screw and moving the center mark, and finally tighten screws on both sides and fix the reticle.

15.4 Adjusting Vertical Angle 0 Datum

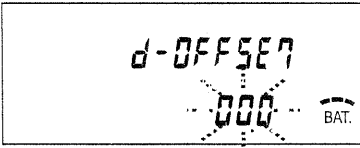
If, when measuring vertical angle of target A at telescope normal and reverse settings, the amount of normal and reverse measurements is other than 360° , half of the difference from 360° is the error amount from corrected 0 setting. Carry out adjustment. As adjustment for vertical angle 0 setting is the criteria for determining instrument coordinate origin, use special care for adjustment.

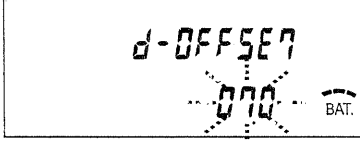
Operating Procedure	Key Operation	Display
<p>① Level the instrument properly with the plate level.</p> <p>② Turn the power switch ON while pressing the  key.</p> <p>After all the segments are shown for approx. 2 seconds, the request for setting vertical angle zero is shown.</p> <p>③ Turn the telescope for normal telescope setting, and set vertical angle zero.</p> <p>④ Sight target A in normal telescope setting. (STEP 1)</p> <p>⑤ Press the  key, and the normal vertical angle data will be stored in the memory.</p> <p>⑥ Turn the telescope and sight target A in reverse telescope setting. (STEP 2)</p> <p>⑦ Press the  key, and the reverse vertical angle data will be stored in the memory. After the offset value can be calculated from the normal and reverse data, the operation will return to the angle measurement mode.</p>	<p> +  ①</p> <p></p> <p></p>	 <p style="text-align: center;">↓ All segments</p>    
<ul style="list-style-type: none"> • If there is any misoperation during checking, display for error appears. Then repeat the above procedure from the start. • Check that the instrument works properly by sighting target A at normal and reverse telescope settings and check if the amount of normal and reverse setting is 360° (or $180^\circ/540^\circ$ when vertical angle display has been set to horizontal zero). 		

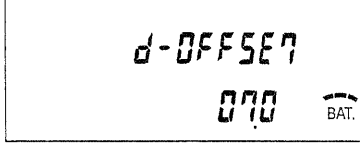
15.5 How to Set the Instrument Constant

Operating Procedure	Key Operation	Display
<p>① Turn the power switch ON while pressing the  key.</p> <p>After all the segments are shown for approx. 2 seconds, the instrument constant previously set is shown going on and off.</p>	 + 	 <p style="text-align: center;">All segments</p>  
<p>② Enter the instrument constant.</p> <p> key: The numerical value of blinking digit increases.</p> <p> key: The numerical value of blinking digit decreases.</p>	<p>Enter instrument constant.</p>	
<p>③ Complete the setting procedure.</p>		
<p>④ Turn the power OFF.</p>		
<ul style="list-style-type: none"> • $\pm 99.9(0.1\text{step})$ 		

16. ERROR DISPLAY

Display	Contents
b	Displayed when it is impossible to read tilting index. Check to make sure instrument is leveled properly. Repair is necessary if the "b" remains after checking for level.
E01	Displayed when the alidade portion of the instrument is rotated too fast (approx. 4 rotations per second). To proceed with measurement, press the (0 SET) key and take measurement.
E02	Displayed when the telescope is rotated too fast (approx. 4 rotations per second). Press the (0 SET) key and "0 SET" appears. Rotate telescope and vertical angle 0°00'00" appear.
E03	Displayed when an internal problem exists with the measuring system. Turn the power switch off once, then on, before putting the instrument into operation. Repair is necessary if the listed procedure does not correct the display.
E04	Displayed in the repetition angle measurement mode when the results differ from each other by more than $\pm 30''$. Press the (0 SET) key and repeat the measurement procedure from start.
E35	Displayed in range of $\pm 6^\circ$ -Zenith or Nadir position in the remote elevation measurement mode and offset measurement mode.
E51	Unable to correct for earth curvature and refraction while in range of $\pm 9^\circ$ -Zenith or Nadir position.
E60	Displayed when the battery power is insufficient for EDM. Charge or replace the battery. Repair is necessary if the error is still displayed.
E65	Displayed when any abnormality has been occurred with EDM. Repair is necessary.
E69	Displayed when data transmission inside the instrument is disabled. Repair is necessary.
E71	Displayed when vertical indexing procedure is done incorrectly. Operate from the beginning.
E72	Displayed when vertical angle "0" point is set extreme wrong position. Level the instrument, then repeat setting of vertical angle "0" position, If E72 continues to display, then repair is necessary.
E73	Displayed when vertical angle "0" position is set without first leveling the instrument. Level the instrument, then repeat setting of vertical angle "0" position. If E73 continues to display, then repair is necessary.
E81	Displayed when the wrong procedure is used for sending data from external equipment (FC series), such as FC-1 to GTS-300 series.
E82	Displayed when the wrong procedure is used for sending data from GTS-300 series to external equipment (FC series).
E99	Displayed when any abnormality has been occurred with GTS-300 series memories. Repair is necessary.

17. SPECIAL ACCESSORIES

TOPCON FC series Data collector
Suitable for systematization of measuring instruments. Measuring data will be automatically stored and transferred to a computer system, making measuring operations more efficient and saving time and effort in such operation.

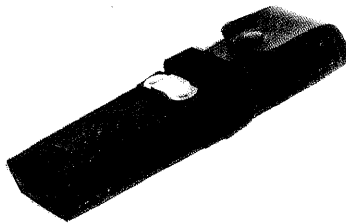

Battery Pack BT-3Q

- Output voltage: DC8.4V
- Capacity: 1.8 AH
- Service life per charging:
approx. 9.5 hours under normal use,
(however, 4 hours for continuous use (+20°C)
including measuring distance.)
- External dimensions:
225(L) × 62(W) × 33 mm(H)
- Weight: 0.7 kg

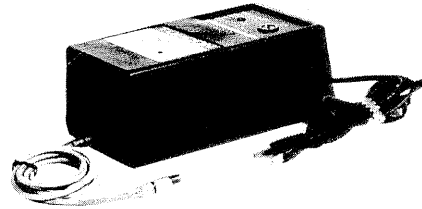

Quick battery charger BC-5

- Input voltage: 100, 120, 220, 240V
AC: ±10% 50/60 Hz
- Power consumption: 40VA approx.
- Charging time:
• approx. 1 hour (+20°C) to charge
external battery BT-3Q
- Operation temperature range:
+10°C to +40°C (+50 ~ +104°F)
- External dimensions:
181(L) × 97(W) × 78 mm(H)
- Weight: 1.5 kg

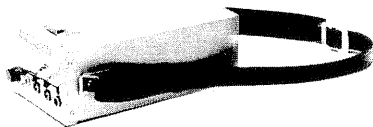

Large capacity battery pack BT-3L

- Output voltage: DC8.4V
- Capacity: 6 AH
- Service life per charging:
approx. 32 hours under normal use,
(however, 13 hours for continuous
use (+20°C) including measuring
distance.)
- External dimensions:
190(L) × 106(W) × 74 mm(H)
- Weight: 2.8 kg

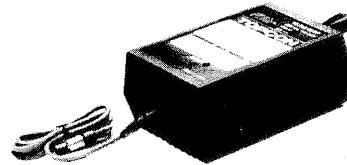

Battery charger BC-6

- Input voltage: 100/120/220/240V
AC ±10% 50/60 Hz
- Power consumption: 15VA approx.
- Charging time: approx. 15 hours (in
+20°C ambient temperature) to charge
BT-3L
- Operation temperature range:
+10 ~ +40°C
- External dimensions:
142(L) × 96(W) × 64 mm(H)
- Weight: 1.0 kg



Power cord PC-3 (For AC-5)

- L-shape plug provided
- Cord length: 2 m approx.



Power cord PC-5 (For BT-3Q)

- L-shape plug provided
- Cord length: 2 m approx.



Power cord PC-6 (For BT-3L)

- L-shape plug provided
- Cord length: 2 m approx.

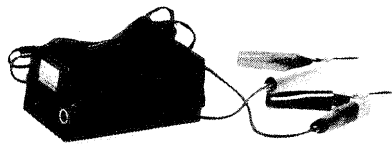

Auto converter AC-5

- Input voltage. 12V DC
- Output voltage: 8.4V
- Cable length: 3 m approx.
- External dimensions:
100(L) × 53(W) × 47 mm(H)
- Weight: 0.3 kg

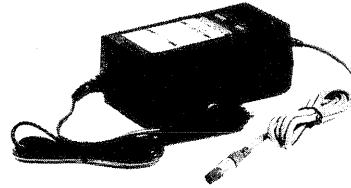

Cigarette lighter charger: BC-9

- Input voltage: 13.8V to 16V
- Power consumption: 40VA approx.
- Charging time:
 - approx. 2 hour
(+20°C) to charge external battery BT-3Q
- Operation temperature range:
+10°C ~ +40°C
- External dimensions:
116(L) × 60(W) × 50 mm(H)
- Weight: 0.3 kg



Diagonal eyepiece, Model 10

Observation in an easy posture will be provided up to the zenith position



Solar filter, Model 6

A filter designed exclusively for direct collimation of the sun.

Solar filter of flap-up type.

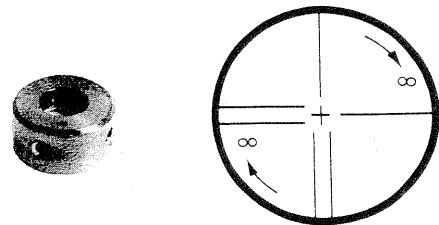

Solar reticle, Model 6

A reticle designed for collimation of the sun. Can be used together with Solar Filter.

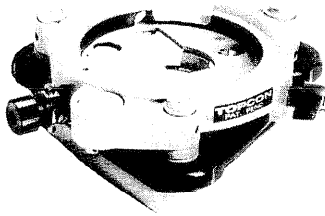

Optical plummet tribrach

This is detachable tribrach having built-in optical plummet telescope (Compatible with Wild)



Trough compass Model 6

Shock proof construction. No clamp is necessary when carrying the instrument. When using this compass use the handle battery BT-24Q.

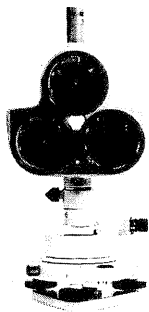

Prism sets

See the description on page 64.

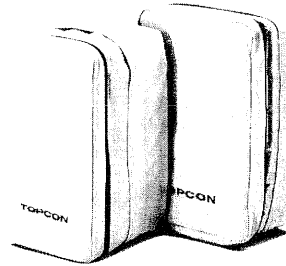

Prism unit case, Model 6

Fixed 9 prisms unit or tilting 3 prisms unit can be stored in this case. Especially, this is a very easy case to carry. Soft material is used.

- External dimensions:
250(L) × 120(W) × 400mm(H)
- Weight: 0.5kg

Prism unit case, Model 5

1 prism unit or fixed 3 prisms unit can be stored in this case. Especially, this is a very easy case to carry. Soft material is used.

- External dimensions:
200(L) × 200(W) × 350mm(H)
- Weight: 0.5kg

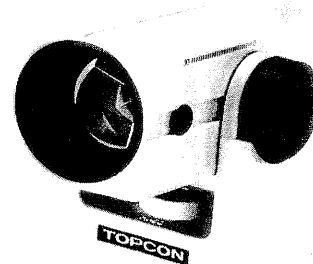

Mini prism

The mini prism (25.4 mm) is made from precision ground glass and mounted in high impact plastic housings.

The mini has the unique capability of being positioned either at a "0" or "−30" with the same prism.

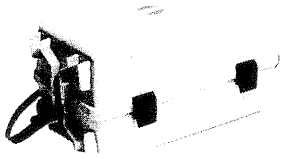

Prism unit case, Model 3

This is the plastic case to store and carry various sets of prisms.

The case covers one of the following prism sets:

- Tilt single prism set
- Tilt single prism set with a target plate
- Fixed triple prism unit
- Fixed triple prism unit with a target plate
- External dimensions:
427(L) × 254(W) × 242 mm(H)
- Weight: 3.1 kg



Gadget case, Model 1

A case to store and carry accessories.

- External dimensions:
300(L) × 145(W) × 220 mm(H)
- Weight: 1.4 kg

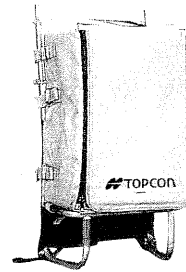

Back Pack, Model 2

Convenient for use in mountainous terrain.

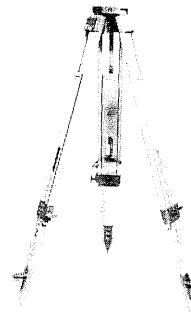

Wide-frame extension leg tripod, Type E (Wood)

- Flat head 5/8" × 11 threads with adjustable legs.

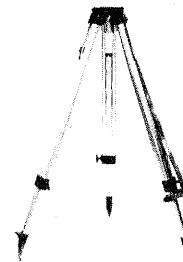

Aluminum extension leg tripod, Type E

- Flat head 5/8" × 11 threads with adjustable legs.

18. BATTERY SYSTEM

- In Case of Handle Battery BT-24Q

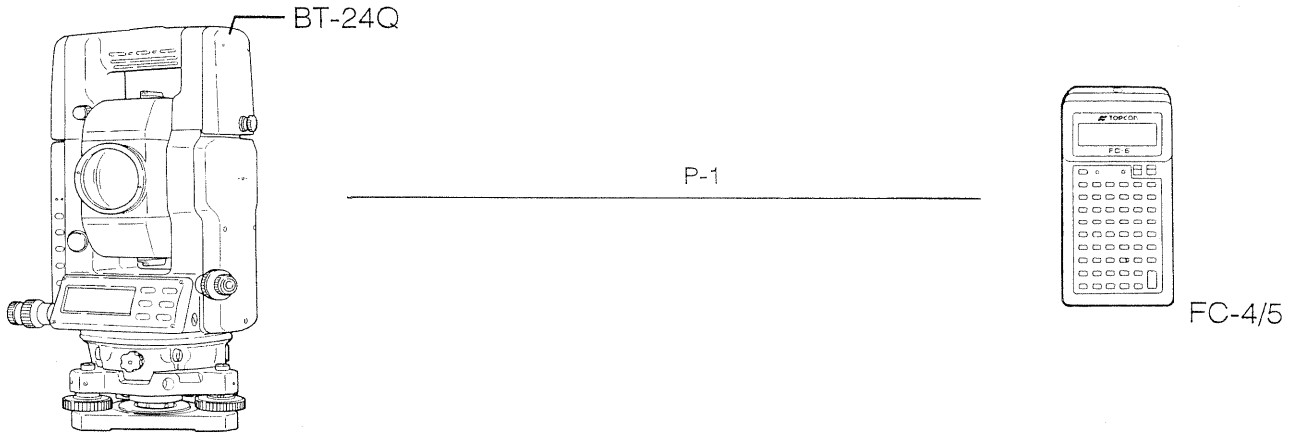

- In Case of External Battery Pack

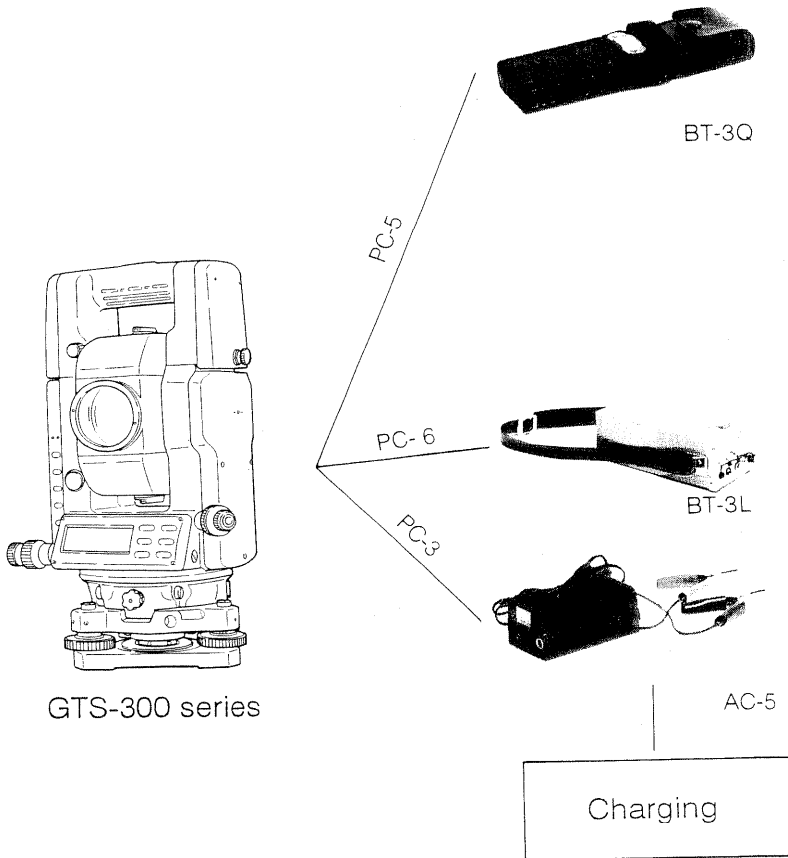

• Charging

Charging time (at 20°C)

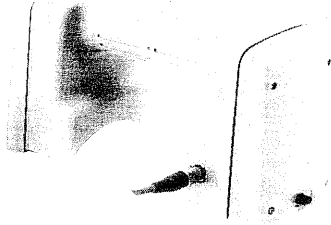

BT-24Q

1.5h

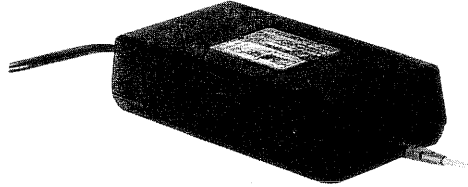

Normal AC 120V.. BC-20B
AC 230V.. BC-20C

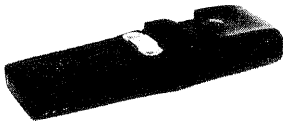

BT-3Q

1h

2h

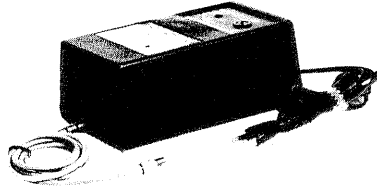

Quick AC 100V/120V
220V/240V

BC-5

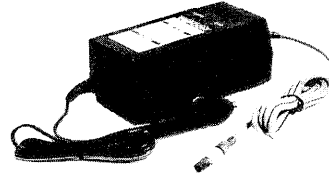

Quick DC 13.8 to 16V

BC-9



BT-3L

15h

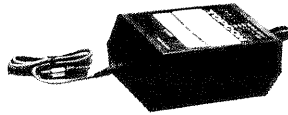

Normal AC 100V/120V
220V/240V

BC-6

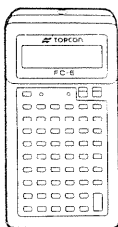

FC-4/5

6h

6h

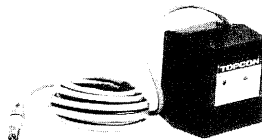

Normal AC 120V... BC-10B
AC 230V... BC-10C

BC-10B

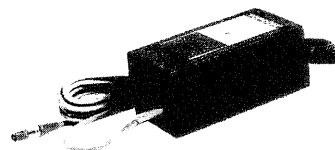

BC-10C

19. PRISM AND REFLECTOR SYSTEM

- Arrangement According to Your Needs is Possible.

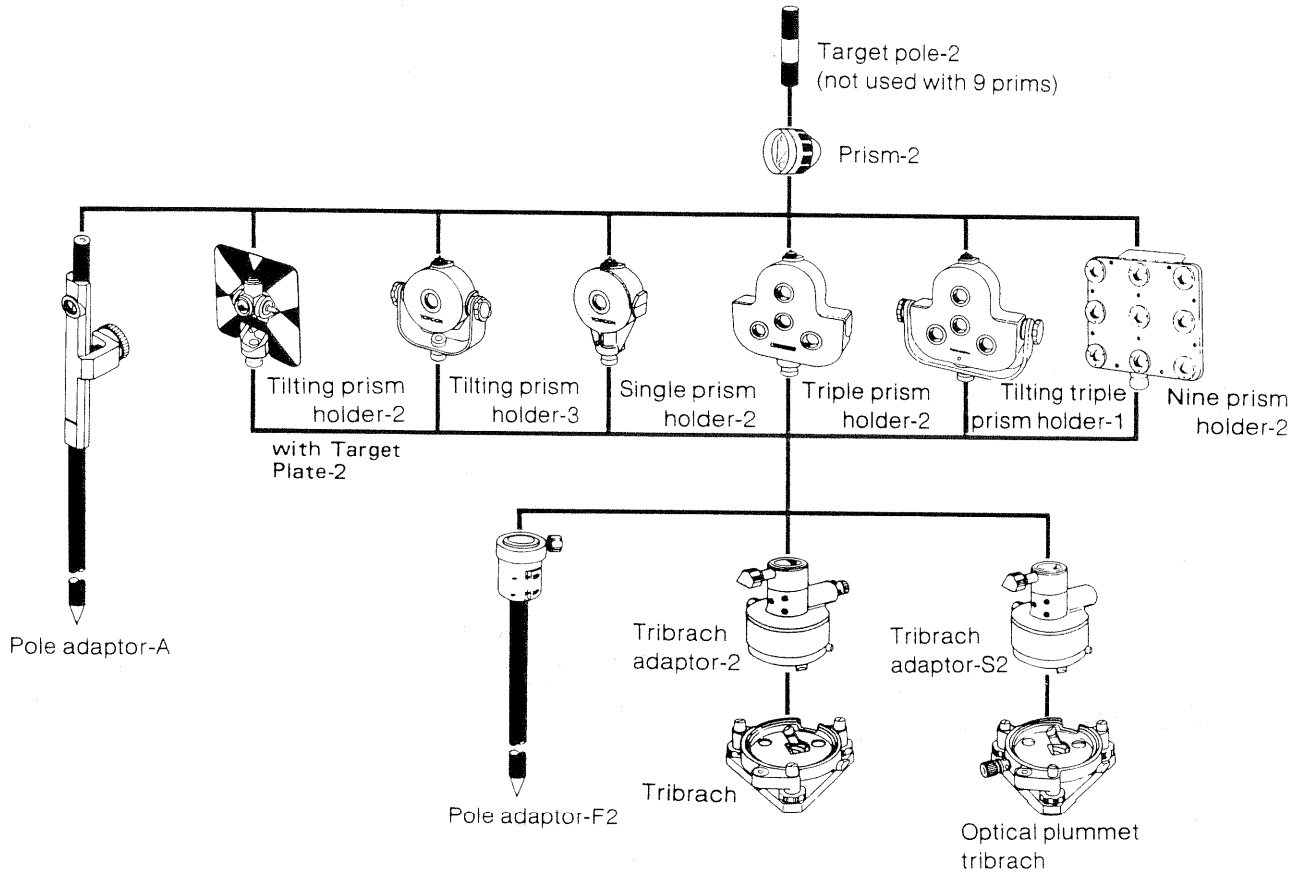

- It is possible to change the combination according purpose

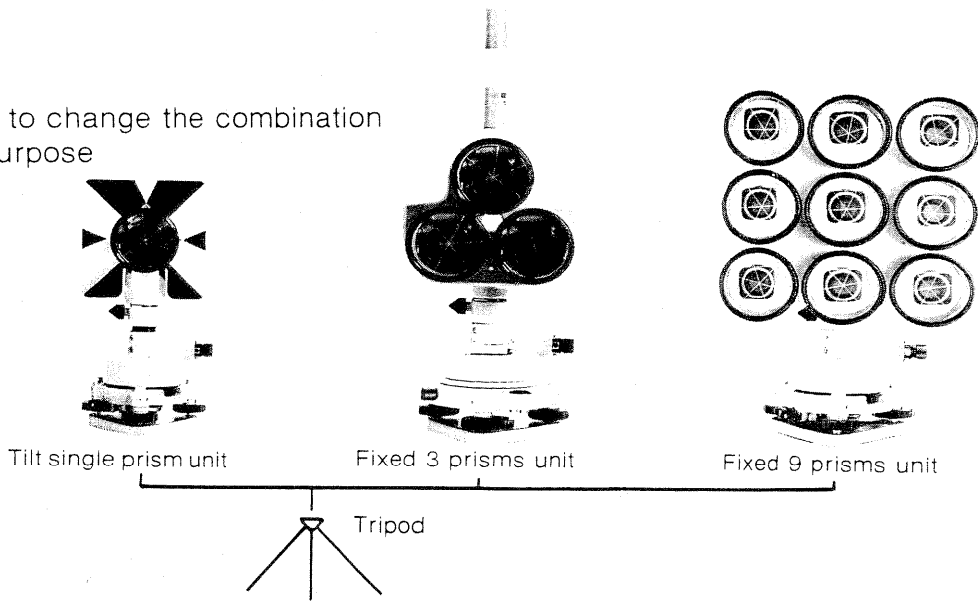

20. SPECIFICATIONS

Telescope

Length	: 150 mm
Objective lens diameter	: 45 mm (EDM: 50 mm)
Magnification	: 30X
Image	: Erect
Field of view (at 1,000 m)	: 1°30'
Resolving power	: 2.5"
Minimum focusing distance	: 1.3 m
Reticule illumination	: Provided

Distance Measurements

Measuring range

		Atmospheric conditions	
		Condition 1	Condition 2
GTS-301D	1 prism	2,400 m (7,900 ft)	2,700 m (8,900 ft)
	3 prisms	3,100 m (10,200 ft)	3,600 m (11,800 ft)
	9 prisms	3,700 m (12,100 ft)	4,400 m (14,400 ft)
GTS-302D	1 prism	2,200 m (7,200 ft)	2,500 m (8,200 ft)
	3 prisms	2,900 m (9,500 ft)	3,300 m (10,800 ft)
	9 prisms	3,600 m (11,800 ft)	4,200 m (13,800 ft)
GTS-303D/303	1 prism	1,200 m (3,900 ft)	1,400 m (4,600 ft)
	3 prisms	2,000 m (6,600 ft)	2,200 m (7,200 ft)
	9 prisms	2,600 m (8,500 ft)	2,800 m (9,200 ft)

Condition 1: Slight haze with visibility about 20 km (12.5 miles) moderate sunlight with light heat shimmer.

Condition 2: No haze with visibility about 40 km (25 miles), overcast with no heat shimmer.

Measurement Accuracy	: $\pm(2 \text{ mm} + 2 \text{ ppm}) \text{ m.s.e.}$
Least Count in Measurement	
Single/Repeat measurement mode	: 1 mm (0.005 ft.)
Tracking/Coarse measurement mode	: 10 mm (0.02 ft.)/1mm(0.005feet)
Measurement Display	: 9 digits: max. display 999999.999 m
Measurement Time	
Repeat measurement mode	: 2.5 sec. (initial 4.0 sec.)
Tracking/Coarse measurement mode	: 0.5 sec. (initial 3.0 sec.)
Atmospheric Correction Range	: -99 ppm to +99 ppm, in 1 ppm increments
Prism Constant Correction Range	: -99 mm to +99 mm, in 1 mm increments
Conversion Factor	: Meter/Feet U.S. Survey Foot : 3.2808333333333333 International Foot : 3.280839895013123
Ambient Temperature Range	: -20°C to + 50° (- 4°F to + 122°F)

Electronic Angle Measurement

Method	: Incremental reading		
Detecting	: 2 sides		
Horizontal	: 2 sides		
Vertical	: 2 sides		
Minimum reading	GTS-301D	GTS-302D	GTS-303D/303
	: 1"/5"	: 1"/5"	: 5"/10"
	(0.2 mgon/ 1 mgon)	(0.2 mgon/ 1 mgon)	(0.5 mgon/ 1 mgon)
Accuracy (standard deviation based on DIN 18723)	: 2" (0.6 mgon)	: 3" (1 mgon)	: 5" (1.5 mgon)
Measuring time	: Less than 0.3 sec.		
Diameter of circle	: 71 mm		
Tilt sensor	: Liquid type		
Method	: Liquid type		
Compensating Range	: ±3'		
Minimum Reading	: 1" (0.2 mgon)		
Instrument height (Tilting axis above tribrack dish)	: 176 mm (0.577 ft.)		

Level Sensitivity

Circular level	: 10'/2 mm
Plate level	: 30"/2 mm

Optical Plummet Telescope

Image	: Erect
Magnification	: 3X
Focusing range	: 0.5 m to infinity
Field of View (at 1.3 m)	: 5°

Size

Instrument	
with Handle battery	: 346 x 190 x 150mm (13.62 x 7.48 x 5.91in)
without Handle battery	: 291 x 190 x 150mm (11.46 x 7.48 x 5.91in)
Weight	
Instrument (without Handle Battery)	: 5.2 kgs (11.5 lbs)
Plastic carrying case	: 3.7 kgs (8.2 lbs)

Handle Battery BT-24Q

Output voltage	: 7.2 V
Capacity	: 2.8 AH
Maximum operating time (when fully recharged) at +20°C (+68°F)	
Including distance measurement	: 6 hours
Angle measurement only	: 24 hours
Normal use	: 13.5 hours
(Calculated in the ratio of 1 (distance measurement):3 (angle measurement))	
Weight	: 0.9 kgs (2.0 lbs)

Battery Charger BC-20B/20C

Input voltage	: AC 120 V/BC-20B, AC 230 V/BC-20C
Frequency	: 50/60 Hz
Recharging time (at +20°C/+68°F)	
Handle battery BT-24Q	: 1.5 hours
Operating temperature	: 10°C to 40°C (50°F to 104°F)
Charging signal	: Red lamp illumination
Weight	: 4 kgs (8.8 lbs)

- *Battery using time will vary depending on environmental conditions and operations done with GTS-300 series.*

Connection of external devices, i.e. Data collector, will also reduce the length of battery use.

PRECAUTION WHEN CHARGING OR STORING BATTERIES

The capacity of battery will be affected and its service life shortened in any of the following cases while it is recharged, discharged or stored.

1. Recharging

Fig. 1 shows how ambient temperature at recharging is related to charging efficiency or as affecting discharge capacity. As seen from the figure, charging at normal temperature is best, and the efficiency decreases as the temperature rises. It is best, therefore, to always recharge the battery at normal temperature to obtain full use to the battery's capacity and enjoy maximum per charge. And the service life of your battery will be shortened if it is frequently overcharged or recharged at high temperature.

(Note: 0.1C charge means that the battery is recharged with 0.1-time current as against its capacity.)

2. Discharge

Fig. 2 shows discharge temperature characteristics. Discharge characteristics at high temperature are the same as those at normal temperatures. The battery is likely to have reduced discharge capacity as well as lower discharge voltage when discharged at low temperature. And the service life of your battery will be shortened if it is greatly overcharged.

(Note: 1C discharge means one with 1-time current over battery capacity.)

3. Storage

See Fig. 3 for how storing period at different temperature levels is related to the remaining capacity. The battery will lose its capacity as storage temperature rises and the storage period increases. This does not mean, however, that the battery performance is damaged when the battery is stored. The battery reduced in capacity, will be restored once it is recharged. Always recharge your battery before use. And recharge and discharge the battery 3 or 4 times to restore its capacity if it has been stored for a long period or at high temperature. Storing at high temperature can adversely affect the service life of your battery.

Your battery has been fully charged before leaving the factory, but its capacity may be affected considerably when it takes several months to reach you, if it is stored at high temperature area or passes through a high-temperature region. Then, the battery must be recharged and discharged 3-4 times to fully restore its capacity.

And the battery should always be stored at normal temperature or lower if it will not be used for any long period. This helps your battery have a longer service life.

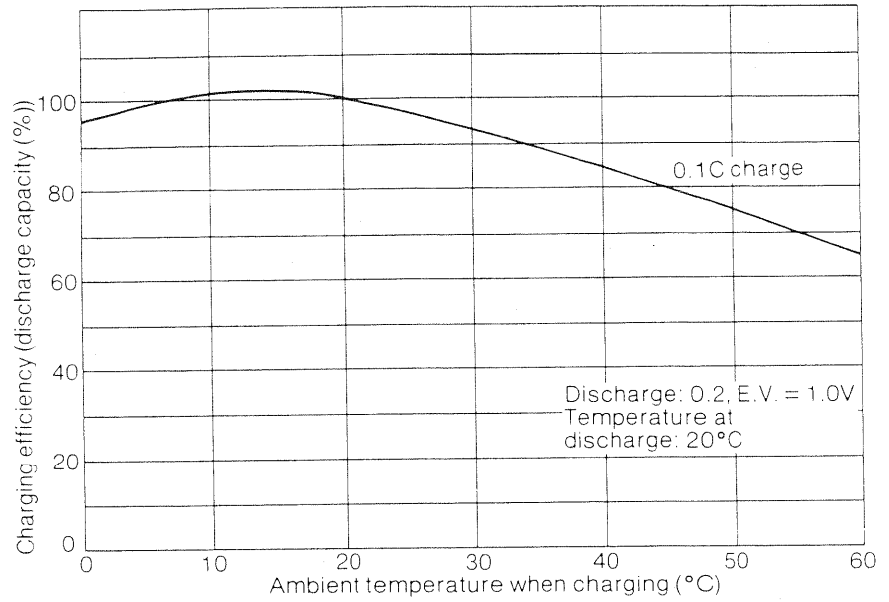

Fig. 1 Recharging

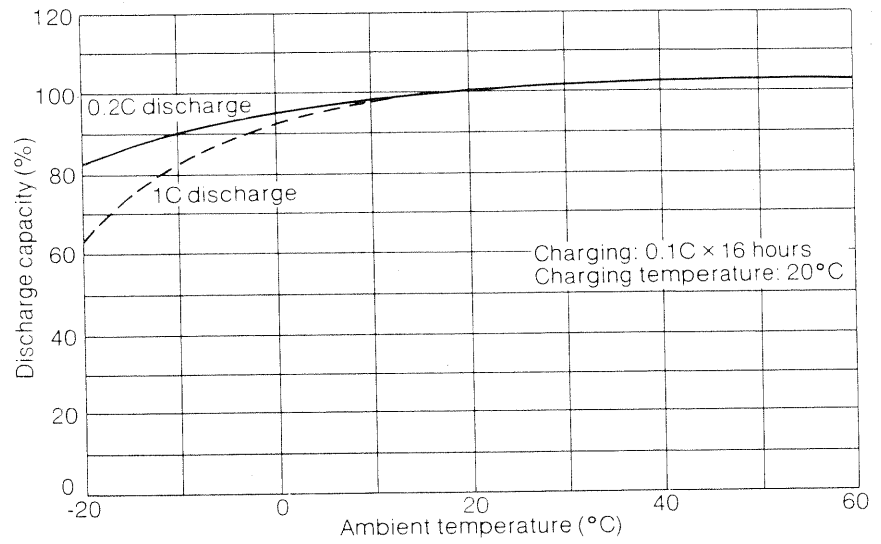

Fig. 2 Discharge

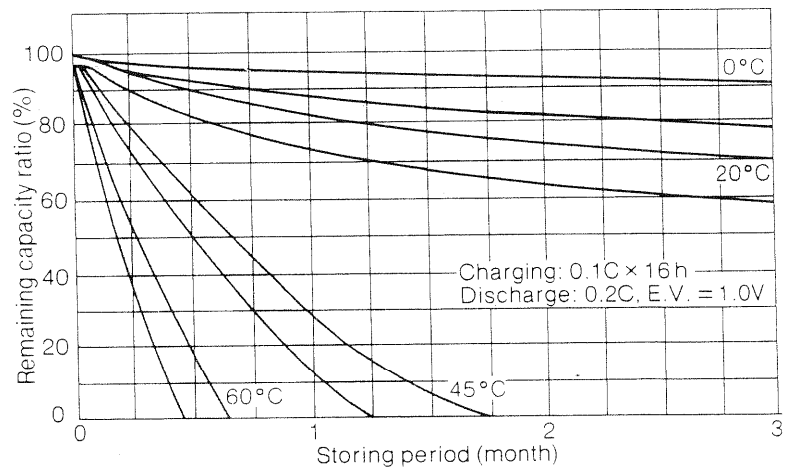
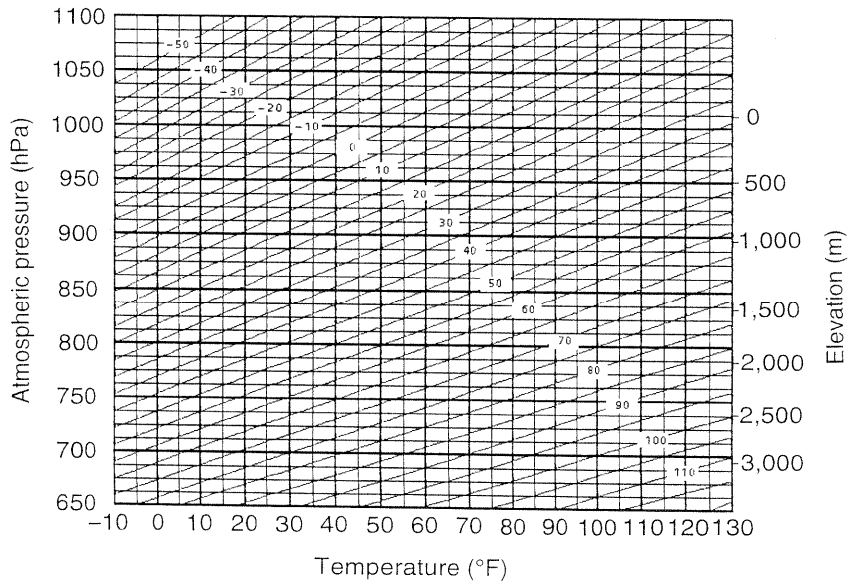
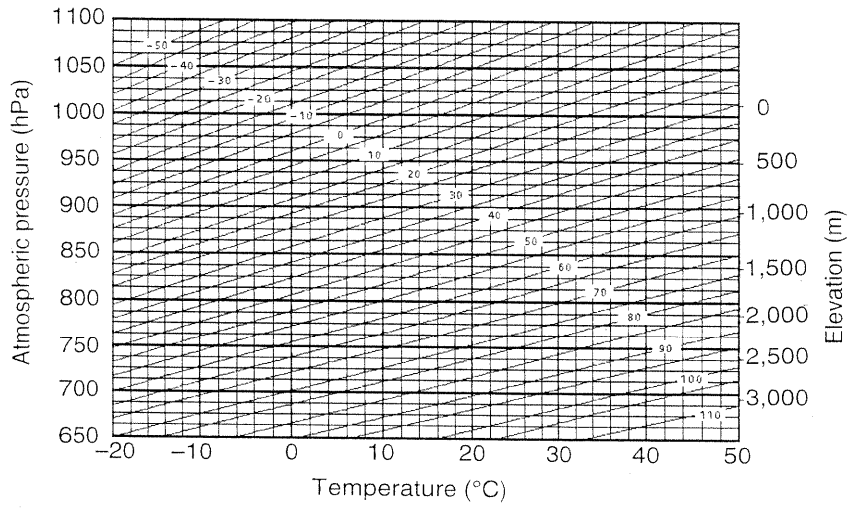

Fig. 3 Storage

Atmospheric Correction Chart (hPa unit)





TOPCON CORPORATION

75-1 Hasunuma-cho, Itabashi-ku, Tokyo, 174 Japan.
Phone: 3-3558-2520 Fax: 3-3960-4214

TOPCON AMERICA CORPORATION

CORPORATE OFFICE

65, West Century Road, Paramus, New Jersey 07652, U.S.A.
Phone: 201-261-9450 Fax: 201-387-2710 Telex: 134338

TOPCON CALIFORNIA

3380 Industrial BLVD, Suite 105, West Sacramento, CA. 95691, U.S.A.
Phone: 916-374-8575 Fax: 916-374-8329

TOPCON MIDWEST

1728 West Algonquin Road, Arlington Heights, Illinois 60005, U.S.A.
Phone: 708-818-9188 Fax: 708-818-9342

TOPCON DENVER

109 Inverness DR, E Unit 1 Englewood, Co 80112, U.S.A.
Phone: 303-706-0920 Fax: 303-373-0998

TOPCON LASER SYSTEMS, INC.

396 Earhart Way, Livermore, CA 94550, U.S.A.
Phone: 510-443-8161 Fax: 510-443-7302

TOPCON EUROPE B.V.

ESSE Baan 11, 2908 LJ Capelle a/d IJssel, The Netherlands.
Phone: 10-4585077 Fax: 10-4585045 Telex: 23783

TOPCON DEUTSCHLAND G.m.b.H.

Halskestr. 7, 47877 Willich, GERMANY
Phone: 02154-9290 Fax: 02154-929-111 Telex: 8531981 TOPC D

TOPCON S.A.R.L.

104/106, Rue Rivay, 92300 Levallois-Perret, FRANCE
Phone: 1-4106 9494 (MEDICAL) 1-4106 9490 (TOPOGRAPHIE)
Fax: 1-47390251 Telex: 620287

TOPCON ESPAÑA S.A.

HEAD OFFICE

Frederic Mompou, 5 08960, Sant Just Desvern Barcelona, SPAIN
Phone: 3-4734057 Fax: 3-4733932

MADRID OFFICE

Avenida Ciudad de Barcelona 81, 1 Planta 28007, Madrid, SPAIN
Phone: 1-552-4160 Fax: 1-552-4161

TOPCON OPTICAL SVENSKA A.B.

Industrivägen 4 P.O. Box 2140 43302 Sävedalen SWEDEN
Phone: 031-261250 Fax: 031-268607 Telex: 21414

TOPCON SINGAPORE PTE. LTD.

Alexandra Distripark, Block 4, #05-15, Pasir Panjang Road, SINGAPORE 0511
Phone: 2780222 Fax: 2733540 Telex: RS 26622

TOPCON AUSTRALIA PTY. LTD.

408 Victoria Rode, Gladesville, NSW 2111 AUSTRALIA
Phone: 02-817-4666 Fax: 02-817-4654

TOPCON INSTRUMENTS (THAILAND) CO.,LTD.

147/229-230, New Southern Bus Station, Pinklao-Nakarnchaisri Rd.
Boromrashinee Road, Bangplad Bangkok, Noi Bangkok 10700 THAILAND
Phone: 662-435-4002 Fax: 662-435-4005

TOPCON INSTRUMENTS (MALAYSIA) SDN.BHD.

Lot 226 Jalan Negara Dua, Pusat Bandar Taman Melawati, Taman Melawat, 53100
Kuala Lumpur, MALAYSIA
Phone: 03-4079801 Fax: 03-4079796

BLOOMFIELD COMPUTING SERVICES PTY. LTD.

408 Victoria Road, Gladesville, NSW 2111, Australia.
Phone: 02-817-4666 Fax: 02-817-4654

TOPCON KOREA CORPORATION

Hyobong Bldg., 1-1306, Seocho-Dong, Seocho-Gu, Seoul, KOREA
Phone: 02-557-9231/2 Fax: 02-556-1928 Telex: K23231 EXT2264

TOPCON OPTICAL (H.K.) LIMITED

2-4/F Meeco Industrial Bldg, NO. 53-55
Au Pui Wan Street, Fo Tan Road, Shatin, N.T. HONG KONG
Phone: 26049688 Fax: 26910264

TOPCON CORPORATION BEIJING OFFICE

Room No. 962 Poly Plaza Building, 14 Dongzhimen
Nandajie, Dongcheng District, Beijing, 100027 CHINA
Phone: 501-4191-2 Fax: 501-4190